

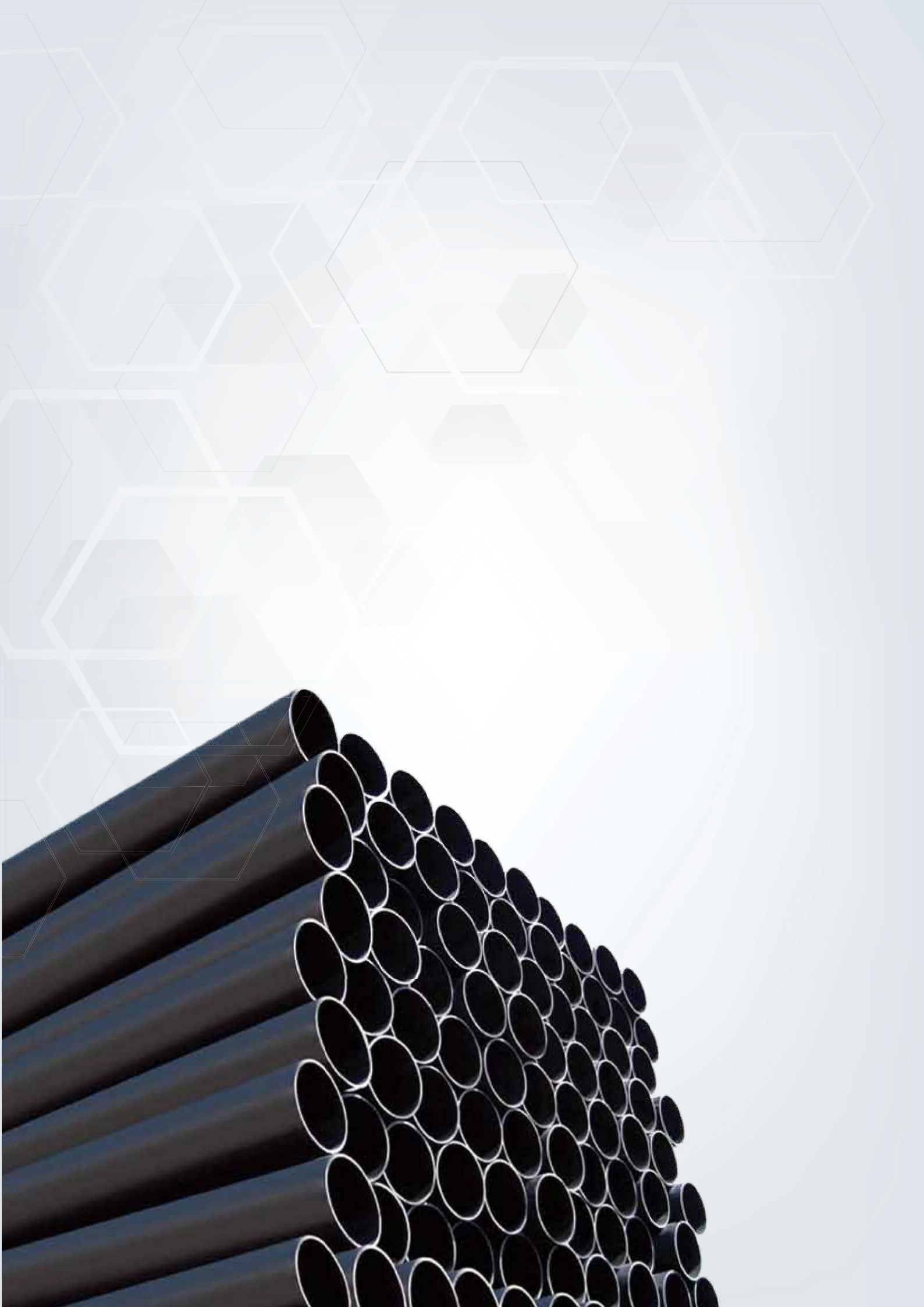

## WAVIN HDPE

FOR HDPE SOIL, WASTE & VENT APPLICATIONS



	Hepworth PME Introduction	3
	Wavin Introduction	4
<b>1</b>	<b>General</b>	<b>5</b>
1.1	Quantities	5
	- Domestic waste water	5
<b>2</b>	<b>Principles of waste water discharge</b>	<b>7</b>
2.1	General design principles	7
	- Overpressures and underpressures	
	- Primary discharge system	
	- Secondary discharge system	
	- Restricted secondary discharge system	
	- Air admittance valves	
	- Direct separated discharge system	
	- Balancing lines	
2.2	Filling of pipework	8
2.3	Fall	8
2.4	Access fittings	9
<b>3</b>	<b>Peripheral requirements for removal of waste water</b>	<b>10</b>
3.1	Traps	10
3.2	Connecting pipes	10
3.3	Collecting pipes	10
3.3.1	General requirements	11
3.3.2	Connections to collecting pipes	12
3.3.3	Connection separations and sequence	14
3.4	Stacks	14
3.4.1	Connections to stacks	15
	- Method	
3.4.2	Angled sections	15
3.4.3	Stack foot and connection-free zones	15
3.4.4	Stack diameter	16
3.5	Underground pipes	16
3.6	Ventilation pipes	16
3.7	Roof penetrations	17
3.8	Discharge of waste water	17
<b>4</b>	<b>Dimensioning for waste water</b>	<b>18</b>
<b>5</b>	<b>Noise</b>	<b>19</b>
5.1	The generation of noise	19
5.2	Noise transmission	19
5.3	Noise reducing measures	20
5.4	Fittings	20
<b>6</b>	<b>Casting in heat cured concrete and extrusion shrinkage</b>	<b>21</b>



<b>7</b>	<b>Installation</b>	<b>21</b>
7.1	Design	21
7.1.1	Fixings	
	- HDPE	
7.1.2	Brackets	21
	- support bracket	
	- clamping bracket	
	- fixed point bracket	
7.1.3	Freely suspended pipework	22
	- temperature differences	
	• cold pipework	
	• warm pipework	
	• hot pipework	
7.2	Installation methods	22
7.2.1	Flexible installation	23
	- flexible installation with expansion sleeves and couplers	
	- flexible installation with flexible connectors	
	- bracket separations for flexible installation	
	- bracket distribution for flexible installation	
7.2.2	Rigid installation (HDPE)	25
	- brackets and bracket separations for rigid installation	
	7.2.3 Cast-in pipework	27
<b>8</b>	<b>Assembly</b>	<b>29</b>
8.1	General	29
8.1.1	Pipework in the waste removal system	29
8.1.2	Fixing equipment (brackets)	29
8.1.3	Storage	29
8.1.4	Oval pipe ends	29
8.1.5	Shortening pipes	29
8.2	Brackets	29
8.2.2	Joints in HDPE	29
	- butt welding	
	- electro-weld sockets	
	- electrical spigot welding	
	- preparation work	
	- welding procedure	
	- use of non-standard pipe	
	- rubber seals	
	- expansion sockets	
<b>9</b>	<b>Situations during construction</b>	<b>33</b>
<b>10</b>	<b>Pressure testing</b>	<b>34</b>
<b>11</b>	<b>Maintenance</b>	<b>35</b>
<b>12</b>	<b>Product list</b>	<b>36</b>



# Hepworth

HEPWORTH PME (LLC) is the region's premier manufacturer and supplier of a comprehensive range of high quality plastic pipes, fittings and accessories used for the distribution and transmission of water, wastewater and gas. Established in Dubai for well over three decades and represented by a chain of branch offices throughout the area HEPWORTH PME (LLC) are able to satisfy the requirements of the industry professionals from its substantial stock holding of products conforming to the various international standards in common use in the Middle East.

The demand for readily available high quality pipes and fittings prompted HEPWORTH PME (LLC) to establish a modern manufacturing facility in Dubai back in 1991. Using the latest equipment and techniques the company produces PVC-U, Polyethylene and GRP pipes in a wide range of diameters. Following further investment in 1999 injection moulding machines were introduced to produce PVC-U, polyethylene and polypropylene fittings. In addition to this fabrication of standard, specialized and bespoke fittings using PVC-U, ABS, PPR, polypropylene and polyethylene is undertaken to provide solutions for the discerning water engineer.

Being the first company of its kind to achieve BS Kitemarks and ISO 9002 accreditation in the region, they are now designated as an ISO 9001:2000 accredited manufacturer. Quality is therefore paramount and this is reflected by the fact that HEPWORTH PME (LLC) holds BS Kitemark licences covering 109 of the locally produced products. We also have FM approval for polyethylene pipe underground fire fighting equipments. Optimum performance and longevity is further assured by the company's commitment to customer training.

At both its purpose built facility in Dubai and on site, training covering the proper installation and use of the range of products is provided to customer's technicians. Here they are instructed in using best practice techniques for jointing of the various piping materials, correct installation of fittings and accessories and operation and maintenance of their systems. Following successful completion of such training courses the technicians will become certified installers of those HEPWORTH PME (LLC) products covered in the course. The benefits of this training are enormous because incorrectly installed systems will certainly fail prematurely at substantial cost to the owner or operator, particularly on those systems that are installed underground or with difficult access.

To complement the range of items manufactured in Dubai, HEPWORTH PME (LLC) also represents a select group of international manufacturers who further enhance the scope of supply to accommodate other aspects of water and gas flow management. Encompassing diverse fields such as irrigation to fire-fighting and district cooling to domestic water supply, complete systems and individual components can be sourced from one professional outlet conveniently located to serve the needs of the specifier or contractor.

HEPWORTH PME have a licensing and manufacturing agreement with Wavin to produce the pipes in Dubai. The fittings will be supplied from Wavin overseas. The pipes are manufactured to EN 1519 specifications which incorporate a test temperature of 110°C.

### Wavin

The Wavin group of companies is one of the largest manufacturers of complete plastic pipe systems for the Building, Civil and Utility markets in Europe. In addition to having its own production facilities in almost every country on the European continent, Wavin also participates in the equity of plastic pipe companies in Australia, New Zealand and Singapore. In the remainder of the world the company is proud of an ever increasing impressive network of licensees, distributors and agents. Wavin has manufactured and supplied plastic pipe systems since 1955. The strength of the Wavin Group in terms of manufacturing capability and technical resources places the company at the forefront of the industry for product quality, innovation, technical support and customer service.

A survey carried out by international consultants for European Plastic News, a leading trade journal, identified Wavin as the foremost contributor in the development of plastic pipe systems and the leader in the field of marketing and technology.

### Wavin Overseas

Wavin Overseas B.V., situated in The Netherlands, is the central export organisation of the Wavin Group dedicated to providing a global service. HDPE Fittings are Manufactured in Italy. Wavin Overseas sells Wavin products, supplies technology (under licence) and equipment to manufacture these products locally. Wavin Overseas is experienced in setting up complete factories, delivering a comprehensive package of manufacturing equipment, ancillaries and services such as production know-how and technical support. In effect Wavin Overseas can supply all the help you need to supply your market. Wavin Overseas operates under a Quality Management System, which is accredited to EN ISO 9001:2000 by the Dutch Council for Accreditation.

### A Wide Range of Products

Wavin's extensive range of plastic pipe systems is designed and manufactured to meet the highest standards set by the building and construction industry worldwide. Wavin's products are generally available ex-stock from one of our numerous distributors around the world.

### Wavin HDPE Product & Technical Guide

This technical manual on HDPE above-ground drainage systems deals with the removal of domestic waste water and rainwater from houses and residential and commercial properties using plastic piping systems. It covers all aspects from design to installation. The manual is intended for clients, architects, construction specialists, building co-operatives, building inspectors and of course for installers. If you have any questions, wishes or practical problems not covered by this manual then we would ask you to submit them to us together with any suggestions for amendments and additions. Since our systems are often utilised in circumstances beyond our control, we cannot accept liability for the consequences of applying the information provided in this manual.

## 1. General

The system is manufactured to EN 1519 specifications which incorporate a test temperature of 110°C.

Water is supplied by means of enclosed pipework systems using internal pressure. Waste water is generated when the supplied water is used for cleaning, washing, cooking and for flushing away human waste. In discussing waste water a distinction is made between black water (from toilets) and grey water (from washing machines, showers and similar). The black water presents a direct hazard to health, grey water does not. Black and grey water are generally discharged together into the above-ground drainage system which carries the water to the underground private sewer (U-drain) into the public sewer or local treatment facility (septic tank). The above-ground drainage system is an open system which is accessible at several locations for dis-

charges of varying kinds, temperatures, quantities, frequencies and so on. On health, hygiene and odour control considerations the system is sealed with traps or siphons. When discharges take place, air in the system has to make way (vented) for waste water. The principal problems of drainage are as follows: intermittent drainage, enclosed open system, complete removal of soil and water is required. Excess rainwater is also led away to the external sewer, nowadays generally to a separate storm drain. If the water is relatively clean it may be led from the storm drain to balancing ponds or waterways. Alternatively, clean rainwater may also be discharged onto the land around the property or into a collective facility. Where the roof is suitable for the

purpose the rainwater may also be used for flushing toilets, washing clothes or cleaning purposes. In that case the rainwater is stored in a tank which must be provided with an overflow. Before proceeding to investigate the principles of drainage it will be as well to determine the nature and quantity of the drainage requirements.

### 1.1 Quantities

#### Domestic waste water

The quantities of water consumed and requiring removal vary appreciably throughout the day and depending on the source of the discharge. 120 to 130 litres per person per day are used as the basis of calculations for supplies required for domestic use. The assumption is that the water used will be led off at the rate of 10 to 12 litres per person per hour.

Illustration 1.1 shows the discharge pattern for a 3 to 4 person household over 24 hours. Basic discharge rates ( $Q_i$ ) to determine the required capacity for a given section of pipework are included in NEN 3215 (see illustration 1.2). Illustration 1.2 also shows the required diameters for the trap and for the pipe connecting to the source of the discharge. The quantity of waste water in collecting pipe stacks, that is, those containing discharges from several fittings, can be determined by means of the formula:

$Q_0 = p \sqrt{\sum Q_i}$ , where  $Q_0$  and  $Q_i$  are in l/s.  $\sum Q_i$  is the sum of the baseline discharge rates to be removed by a collecting pipe.

$p$  is a coefficient for simultaneity:

- houses and residential properties  $p = 0,5$
- schools, offices, hotels, restaurants, hospitals  $p = 0,7$
- laboratories, sustained industrial discharges  $p = 1,2$
- commercial kitchens  $p = 1,4$

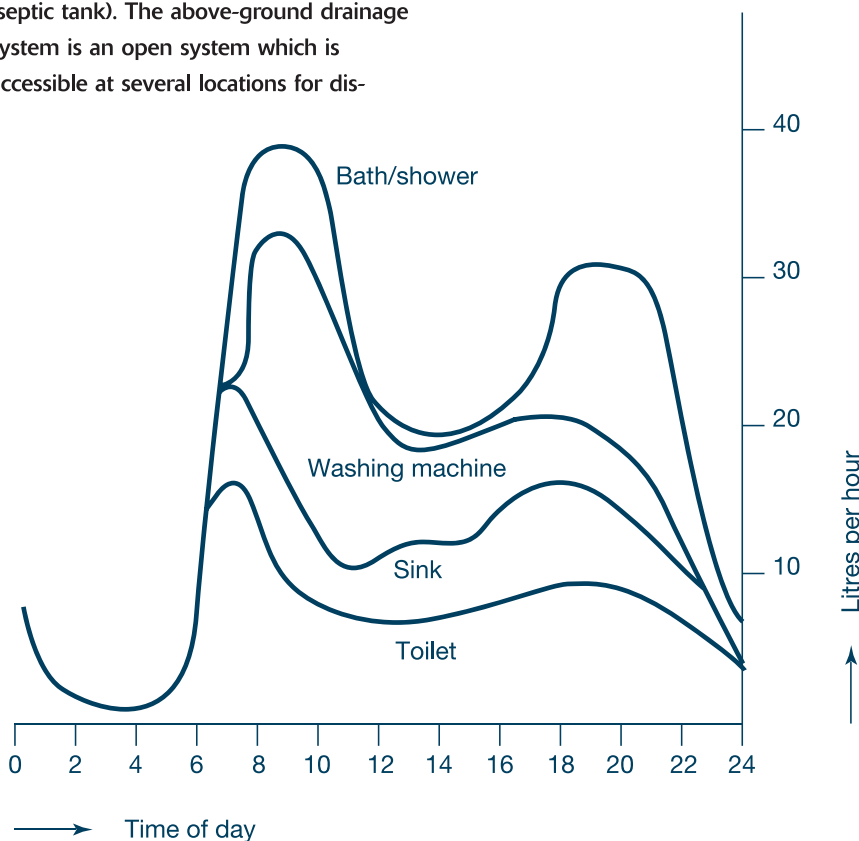

*Illus. 1.1 Mean water consumption for an average household over 24 hours.*

Bath/shower	41	l/pp.day
Toilet	33	l/pp.day
Washing machine	20	l/pp.day
Sink	17	l/pp.day
Various	9	l/pp.day
<b>Total</b>	<b>120</b>	<b>l/pp.day</b>

fitting	baseline discharge l/s	diameter of trap (pipe type) (mm)	external diameter connecting pipe in PVC and PE (mm)	reduced external diameter for wall and floor piping (mm)
mouthwash unit drinking fountain leakage removal overflow hopper	0	32	40	32
hand washbasin washbasin shower without tray bidet	0,5		50	40
automatic washing machine domestic dishwasher urinal footbath kitchen sink (single or double) slop sink	0,75	40	63 (HDPE) or 75 (PVC)	50
bath shower with tray sink with capacity over 30 l	1,0			
Toilet	2,0	-	110	90
siphonic closet bedpan sluice	2,5	-	110	90
floor drain 32 mm	0,5	-	50	40
40 mm	0,75	-	63/75	50
50 mm	1,0	-	63/75	50
70 mm	1,5	-	75	-
100 mm	2,0	-	110	-

<sup>1)</sup> reduction permissible if

- total length of connecting pipework is no more than 3,5 m.
- length of wall-mounted pipe (horizontal) is no more than 0,5 m and only a single vertical element is not longer than 1,5 m.

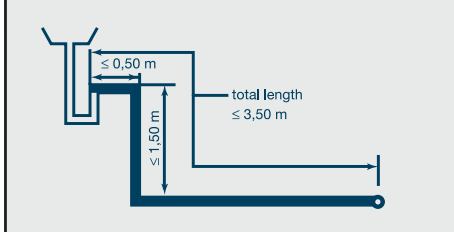

Illus. 1.2 Baseline discharge, required diameter for traps and (reduced) connecting pipework for a variety of fittings.

$Q_0$  can be read off for different values of  $p$  in illustration 1.3 if the sum of  $Q_i$  is known.  $Q_0$  may never be lower than the highest value for baseline discharge rates.

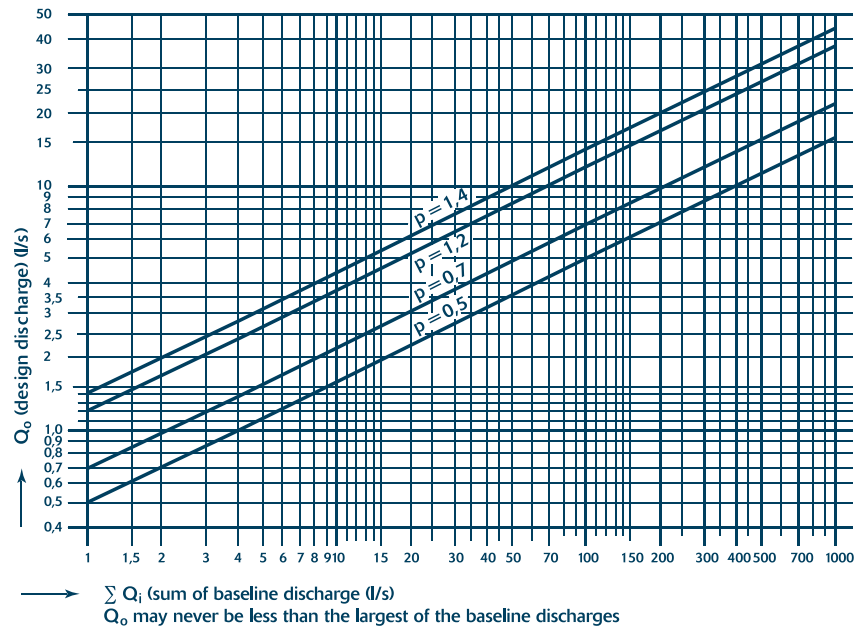

Illus. 1.3. Relationship between  $Q_0$ ,  $p$  and  $Q_i$ .

Example:

Calculated using table in 2 gives  $Q_i = 52$  l/s

Office ( $p = 0,7$ ) hence  $Q_0 = 5$  l/s



## 2. Principles of waste water discharge

In houses and other residential properties waste water and rainwater must be collected separately and led to the exterior of the building, or at least up to the location of a discharge construction for the rainwater. It is important in removing waste water that the pipework empties thoroughly, that any soil is carried along by the water and that no waste water or sewer gases enter the building via the trap. Discharges will

cause compression of air, and overpressures and underpressures will be created. These must be kept within limits. Steps must also be taken to prevent excessive overpressures or underpressures created by hydraulic sealing, whereby little or no air can pass over or through a flowing mass of water. The principles and stipulations for the removal of waste water are based upon these assumptions. Having dealt with general construction principles,

this chapter goes on to discuss the waste water system from the fitting to the building boundary. Requirements and problems are examined and solutions suggested.

### 2.1 General design principles

In order to prevent traps being emptied by suction or pressure, overpressures and underpressures must not exceed 300 Pa (30 mm water column). Air must be able to escape from the system (venting) and to enter the system (admittance). A ventilated discharge pipe is used for this purpose. Good practice is to create a primary discharge system extending the discharge stack above roof level (see illustration 2.1). This system allows air to continually enter and vent from the main sewer. In the case of a secondary discharge system, each fitting or branch pipe is connected to a separate ventilation system. A secondary discharge system may be taken through the roof or connected to a primary discharge system prior to this being taken through the roof (illustration 2.2). An unavoidably long branch pipe may give rise to problems in a primary system. The section of the branch pipe furthest from the stack may then be connected to a restricted secondary discharge pipe. This may either be led directly through the roof or connected to the stack or to the primary discharge stack. This may be referred to as a circulating or end discharge system (illustration 2.3). In this case an internal air admittance vent on the end of the branch pipe may be useful. However these can only admit air to the system, not release it.

Where overpressure occurs in the system a membrane is pressed closed, otherwise sewer stench would enter the room. The air admittance surface area must be as close as possible to the cross sectional area of the collection stack. For ease of maintenance the air admittance vent must be fitted in accessible place

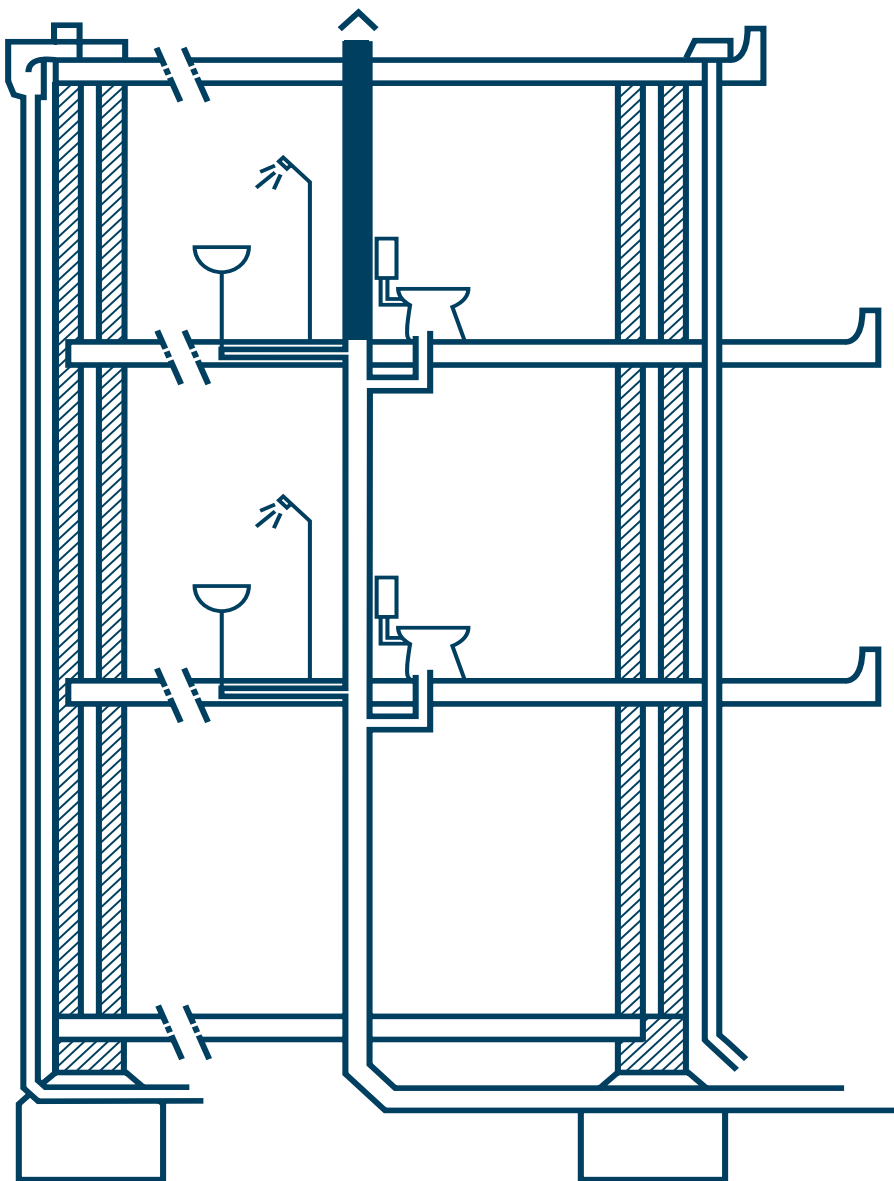

Illus. 2.1 Principles of the primary discharge system.

above the level of the fittings. An air admittance valve may also be useful in solving problems associated with separate discharging fittings. However they cannot take the place of the (primary) vent pipe.

A separate direct discharge system (or direct parallel discharge system) may be employed to solve problems where additional fittings are connected to an existing system. This may facilitate air movement, while hydraulic sealing has less effect and the capacity of the stack may increase. Such a discharge pipe will be connected exclusively to the stack, that is, no branch pipe will be connected (illustration 2.4). In places in the system where hydraulic sealing may be caused occur because of bends, transitions from vertical to horizontal or where insufficient

airflow is possible, a balancing line may be provided. This line allows the balancing of overpressures and underpressures. One common example arises if the stack is not fully vertical but has horizontal sections (illustration 2.5). The uppermost example, a restricted secondary discharge system, is the most common solution. The recommendations in this manual are based upon the presence of a primary discharge system.

### 2.2 Filling of pipework

In order to allow a free flow of air the pipework must be designed to take account of the quantities to be removed, the fall (= gradient or hydraulic slope) and the diameter, so that the pipes are no more than 70% full (water depth is 0.7 x the internal pipe diameter).

Equal discharge and flow are assumed. This will not be the case immediately downstream of the fittings, but the wave of water will be equal after some time (and some length of pipe) has passed.

### 2.3 Fall

A certain flow rate is required to correctly remove foul water. A lower limit of 1:200 has been established for this purpose. 1:400 or 1:500 may be possible with shorter runs, on condition that a calculation is provided. In practice the installation will then have to be carried out with great care. Further, any hydraulic disturbances must be minimised: a fitting upstream that is frequently used and/or has a fairly large baseline discharge is an advantage in this case. In general a maximum fall of 1:50 is maintained to prevent

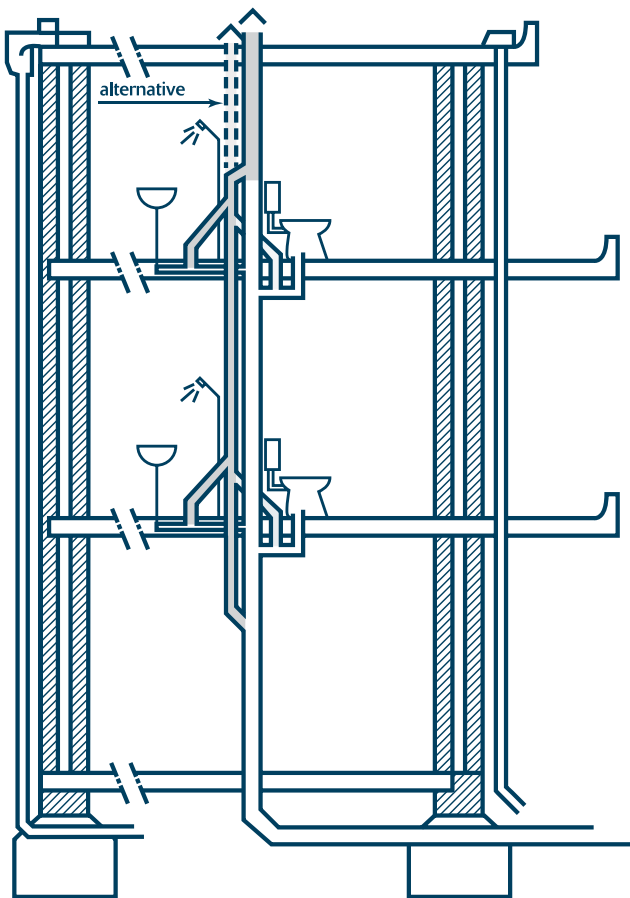

Illus. 2.2 Principles of secondary discharge system.

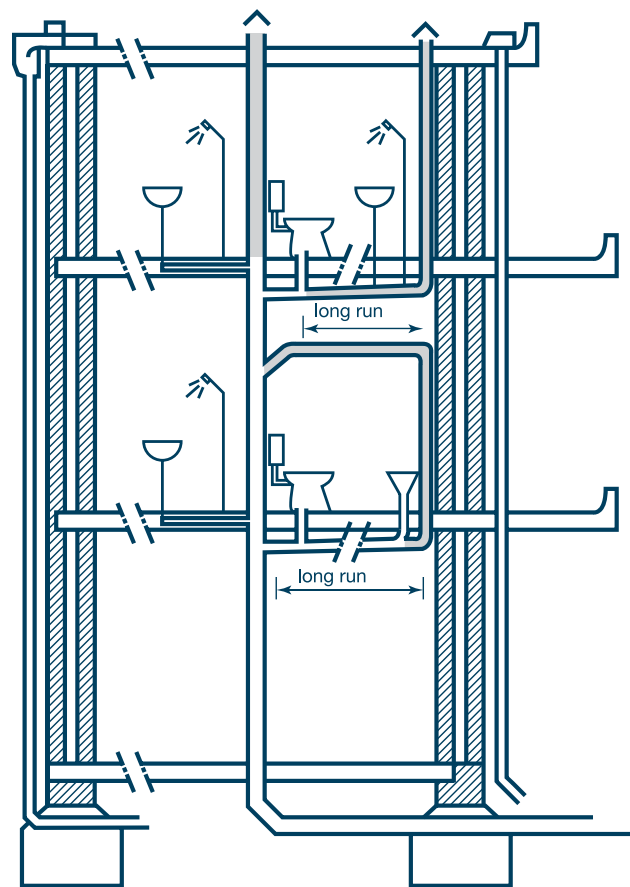

Illus. 2.3 Example of restricted secondary discharge system.

water flowing away too quickly, which can give rise to hydraulic sealing.

### 2.4 Access fittings

Blockages may occur even in well-designed discharge systems, for example as a result of deposits (e.g. solidified fat) or improper use of the drain (paint residues, food remnants, cat litter, potting compost, small objects, etc). Access fittings should therefore be provided at strategic locations in the pipework, taking account of the fact that clearing equipment can only cope with limited changes in direction. Access fittings should be easily accessible and placed in such way that hoses or springs can easily be inserted. The access fitting should where possible be located on top of the pipe so that in the case of blockages the whole pipe does not empty if the cap is removed.

Stacks can often be cleaned from the roof provided the vent cap can be removed. With high buildings it is recommended that an access fitting be provided every 3 to 4 storeys. Ventilation lines, including secondary ventilation, may become (partly) blocked when rainwater gets in or by deposition of dry matter from the environment. Vent lines should therefore also be provided with access fittings.



Access Fitting

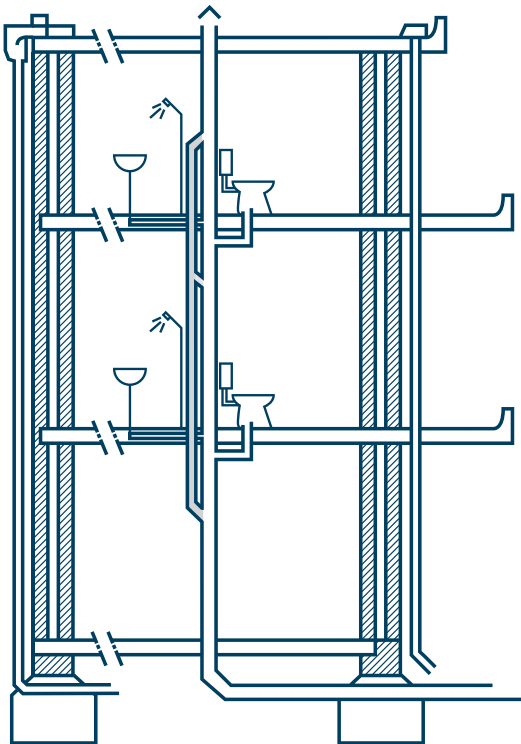

Illus. 2.4 Principles of the direct separate discharge system (the stack discharges directly).

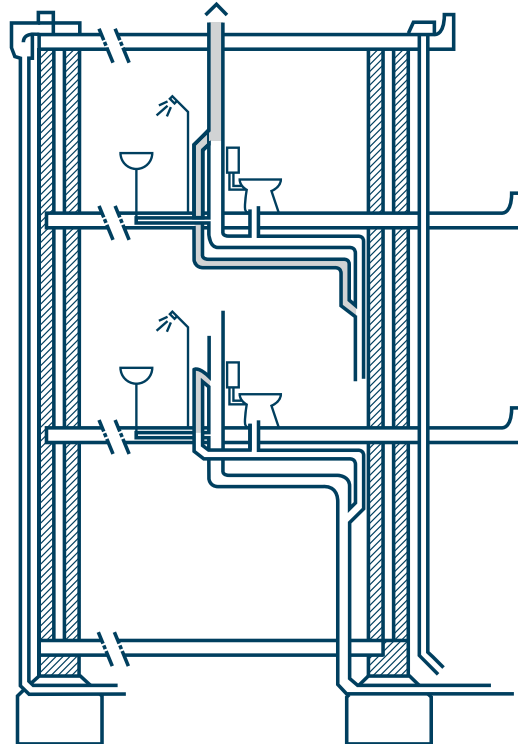

Illus. 2.5 Examples of balancing pipework. The uppermost method is most commonly applied.



As well as proper calculation and selection of the appropriate diameter, a number of other factors are important to achieve good operation and prevent hydraulic seals, fouling of pipes and excessive overpressures and underpressures. This chapter deals with these peripheral requirements. For this purpose we now follow the pipework from the source of the discharge onwards.

#### 3.1 Traps

Each discharging fitting must be provided with a trap. A certain diameter will be required, depending on the baseline discharge level (see illustration 1.2). If too small a diameter is chosen then emptying of the fitting will take too long. Self-siphoning (emptying of the trap through suction when the fitting is discharged) may occur, and noise will increase. On the other hand, an excessive diameter will lead to a lower speed of flow. This results in greater difficulty in carrying away soiling and blockages may result. There must be at least 50 mm of water (500 Pa) in a trap. The seal will remain intact if a maximum underpressure of 300 Pa arises in the system, even if some of the water in the trap has evaporated. Traps with rubber seals are to be preferred because of easier cleansing and replacement. This also prevents problems arising from the use of different materials. There are two main types of trap, the tubular (M,D,PS types) and the bottle type (which includes floor-mounted varieties). Each type has its advantages and disadvantages. The bottle types are more readily blocked, but also more easily cleared. The bottle types lose less water to evaporation and are less sensitive to pressure differences (there is more water to be put into motion). A tubular trap is less prone to blocking because the speed of flow is higher and the shape allows free flow.

#### 3.2 Connecting pipes

Every fitting must be separately connec-

ted using a connecting pipe. During discharge the connecting pipe must be completely filled with water. No requirements are therefore set down for the minimum fall. Some fall is certainly required however as the pipe must empty fully. If the pipe is completely filled a plug of water is created which can cause underpressure. This empties the trap by suction and gives rise to gurgling sounds (illustration 3.1). Complete filling of the pipe must therefore make way as rapidly as possible for partial filling. Significant here are the length of the connecting pipe, its diameter, whether the pipe runs vertically or horizontally and the number of changes in direction. The required diameter is stated in illustration 1.2. If the total length of the connecting pipework from the trap to the common stack is greater than 3.5 metres then a diameter required for the excess must be determined as if it were a collecting stack, using 3.3 and illustration 4.1. The total length of a connecting section may not exceed 12 metres. The diameters of parts a and b in illustration 3.2 may be smaller provided the following conditions are met:

- total length less than 3.5 metres
- part a less than 0.5 metres
- part b less than 1.5 metres (total of the vertical sections).

The diameter thereby permitted is stated in illustration 1.2. In view of the possibility of damage and for maintenance it is recommended that a rubber sleeve should be used in the floor (at location x).

#### 3.3 Collecting pipes

Many different factors may affect collecting pipes.

This accounts for the many conditions set down to achieve the problem-free removal of waste water.

These requirements serve two main aims:

- To ensure that free-flowing air remains available above the water.
- To ensure that no fouling takes place.

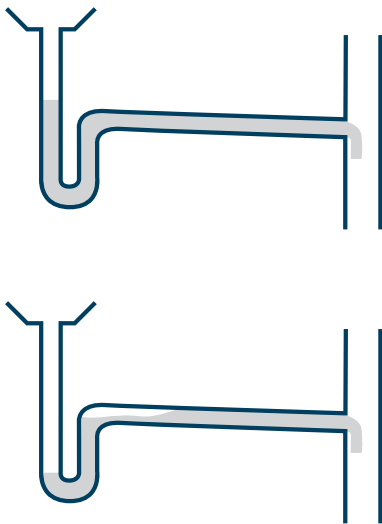

*Illus. 3.1 Self-siphoning or suction emptying of the trap.*

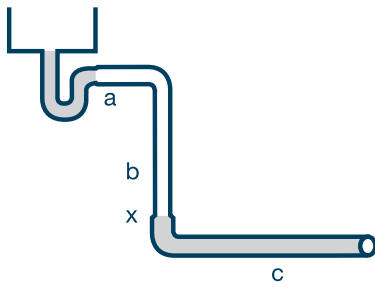

$a < 0,5 \text{ m}$   
 $b < 1,5 \text{ m}$ ; if  $b > 1,5 \text{ m}$   
 calculate as a stack  
 $a + b + c < 3,5 \text{ m}$ ; if  $> 3,5 \text{ m}$   
 calculate as a collecting pipe

Illus. 3.2 Conditions for reduction in diameter of a connecting pipe, see also illustration 1.2.

### 3.3.1 General requirements

The diameter must be determined on a section by section basis (from connecting section to connecting section).

- Collecting pipes must be as straight and as short as possible.
- Bends must not be tighter than 45°.
- To prevent soil being left behind, the maximum sum of changes in direction depends on the fall (illustration 3.3). If the sum of changes in direction is larger, the next largest diameter should be selected for the extra length, unless discharge takes place upstream.
- For a section with no toilet, the maximum length may be 12 metres, if two fittings are connected, where the Qi for one of these is no greater than 0.5 l/s (illustration 3.4).
- For a section including a toilet and other fittings with Qi less than 0.75 l/s, the permitted maximum length is dependent on the fall (illustration 3.4).

Additionally, the maximum permitted sum of changes in direction is 135°. Where these conditions are met the flushed contents of the pan can reach the vertical stack or underground pipe in one go and blockages and deposits are prevented. Length is taken to mean the horizontal length from the toilet to the vertical stack or underground pipe.

- All reductions in the collecting pipe must be eccentric (top of pipe at a single level).

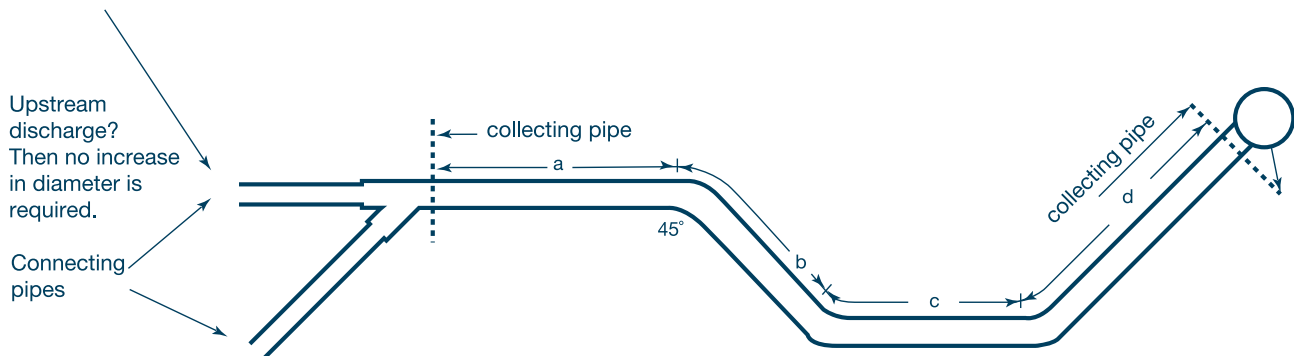

from	to	max sum of changes of direction	example:
1:50	1:75	22 1/2 °	1:200 section d larger Ø
1:75	1:100	45°	1:150 section d larger Ø
1:100	1:140	67 1/2 °	1:100 section c en d larger Ø
1:140	1:180	90°	1:50 section b,c en d larger Ø
1:180	1:200	112 1/2 °	

Where these limits are exceeded, the next diameter up should be selected for the extra length, unless discharge takes place upstream.

Illus. 3.3 Maximum permissible sum of changes of direction for a particular fall in collecting pipes.

toilets and other fittings	maximum length	maximum permissible sum of changes of direction
toilet only (=connection pipe)	3,5 m	135°
toilet only (calculated as collecting pipe) and toilet + fitting $Q_i < 0,75$ l/s	* 1:50 ; 12 m 1:100 ; 8 m 1:200 ; 5 m	135°
toilet + fitting $Q_i \leq 0,75$ l/s (i.e. 2 or more toilets)	no restrictions	see illustration 3.3
1 fitting no toilet (= connecting pipe)	3,5 m	-
1 fitting no toilet (calculated as collecting pipe)	12 m	see illustration 3.3
2 fittings no toilet where one $Q_i < 0,5$ l/s	12 m	see illustration 3.3
2 fittings no toilet both $Q \geq 0,5$ l/s	no limitations	see illustration 3.3
* applies for length of toilet connecting pipe + length of collecting pipe		

Illus. 3.4 Maximal length of horizontal pipe and maximal sum of changes of direction when connecting toilets and other fittings.

### 3.3.2 Connections to collecting pipes

- Horizontal connections must be made with 45° T-pieces.
- Side connections:
 

All reductions at horizontal connections of connecting pipe sections to the collecting pipe must be eccentric. The upper surfaces of the pipes must be at a single level so that air can continue to flow and soiling can not flow back (illustration 3.5). If eccentric reducing T-pieces were available they would have to be provided in left and right handed models. In practice a piece with equal diameters is used with an eccentric reducing piece inserted in the appropriate side. N.B. a "running" reducer is better from a hydraulic perspective and makes less noise than an inserted reducer does.
- Oblique connections:
 

Reducing T-pieces may be used with oblique connections provided the angle with the horizontal is between 30° and 45° (illustration 3.6). This connection is acceptable from a hydraulic viewpoint as the water flow in the collecting pipe is not unduly disturbed by the entry of the flow of water. This is a good solution to prevent foul water flowing back from the collecting pipe.
- Top connection:
 

Must be avoided wherever possible. A top connection leads to serious disturbance in the horizontal pipe and hydraulic sealing may occur. Where there is no alternative then a top connection is permitted only where the horizontal pipe is at least 110 mm and the  $Q_i$  of the connecting pipe is no more than 1 l/s. 45° and 90° reducing T-pieces may be used in this case (illustration 3.7).

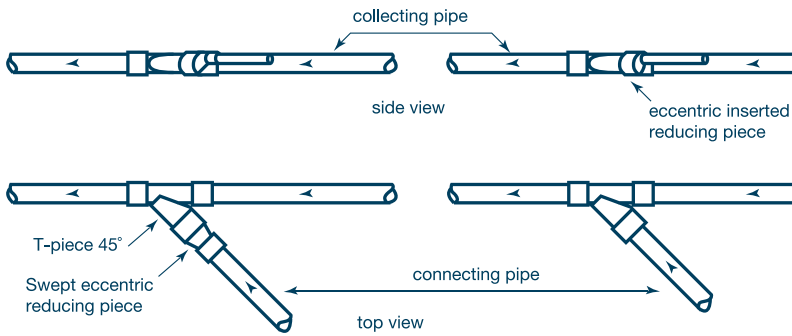

Illus. 3.5 Horizontal connection to collecting pipe with eccentric reducer.

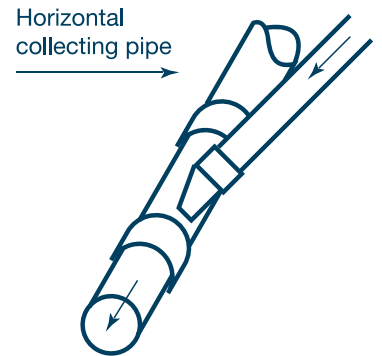

Horizontal collecting pipe  
 45° reducing T-piece with connecting pipe between 30° and 45° with horizontal section  
 < 30° as in illustration 3.5.  
 > 45° conditions as in illustration 3.7

Illus.3.6 Oblique connection.

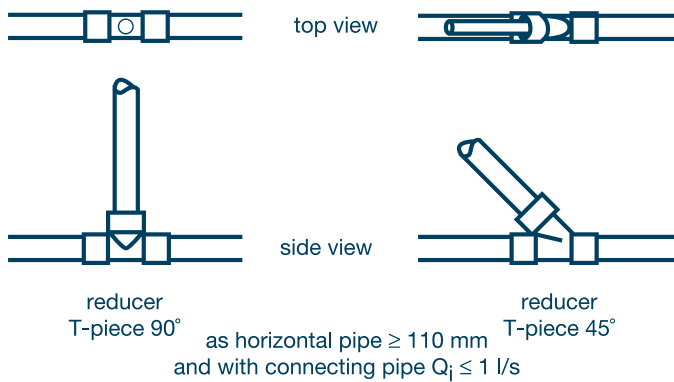

Illus.3.7 Top connection.

**3.3.3 Connection separations and sequence (illustration 3.8)**

In order to prevent interactions as much as possible there are requirements set down for separation distances. The distances are so selected that a subsequent connection smooths out the flow from the previous connection, allowing adequate air to remain above the water level.

- The separation must be at least  $5 \times D$  of the collecting pipe. If the collecting pipe is at least 110 mm and the calculated  $Q_i$  of the pipe furthest upstream is no more than 0.75 l/s then the distance may be  $2 \times D$ .
- If a toilet, dishwasher or washing machine is connected upstream of a floor-gully shower connection, then the separation must be at least 1 metre to prevent hydraulic sealing through the large quantities of water and siphoning of the shower trap seal.
- No other connection may be made for a length of 1 metre downstream of a toilet connection unless that other connecting pipe is provided with a discharge.
- Only toilets and no other fitting may be connected upstream of a toilet connection, unless the connecting pipe is provided with a discharge. The upstream fitting (not being a toilet) may be connected (at least 1 metre) downstream of the toilet connection (illustration 3.9).
- Strive to connect fittings with a high  $Q_i$  to the upstream section of the collecting pipe, so as to prevent fouling and deposition as much as possible in that section. In order to prevent interactions as much as possible there are requirements set down for separation distances.

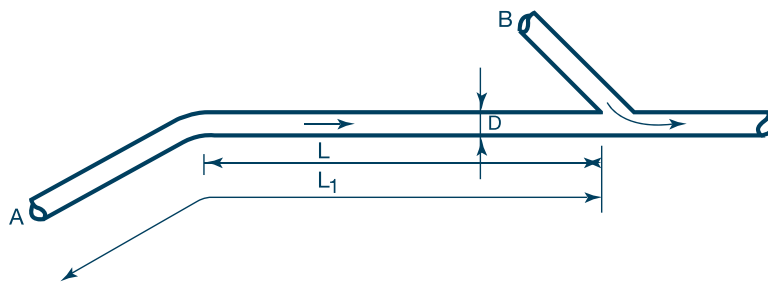

A Fitting	B Fitting	L
1 any, unless a toilet	any, unless a toilet	$\geq 5 \times D$
2 any, if $Q_i \leq 0,75$ l/s	any, unless a toilet	$\geq 2 \times D$ , if $D \geq 110$ mm
3 toilet, dishwasher or washing machine	floor gully shower	$\geq 1$ m ( $L_1$ )
4 toilet	toilet	$\geq 5 \times D$
5 toilet	any, (no floor gully shower) if with secondary discharge to B	$\geq 5 \times D$
6 any (not a toilet)	toilet	if connected $\geq 1$ m downstream of B, illustration 3.9

Illus. 3.8 Connection separations and sequences.

**3.4 Stacks**

Since the upwardly extended section of the stack also serves as the vent line in a primary discharge system, great care must be taken to ensure that no hydraulic sealing or excessive pressure differences arise. A free flow of air, including the collecting pipework, is of crucial importance. The vulnerable areas are: the in-flow from the collecting pipework and any bends, including that at the foot of the stack where this enters the underground pipe, and any angled bends or horizontal branches in the stack. When waste water is discharged into the stack it will flow down, after passing a short length, more or less along the pipe walls. A column of air with some water will also be drawn downwards. The air and the pipe wall will slow the falling water. Depending on the diameter and the quantity of water, the

speed of flow will be between 7 and 11 m/s after 10 to 15 metres and will not increase beyond this. 5 to 12 times as much air as water is required. The supply of air via the ventilating pipe is therefore essential. It is important here that the stack is as straight as possible. An underpressure will be created in the upper section of the stack. This may not exceed 300 Pa for stacks used for removal of waste water (traps must be 500 Pa = 50 mm). The determination of diameter as shown in illustration 4.2 is based on this. The diameter of the stack may not be smaller than that of any one of the collecting pipes connected upstream. Overpressure will exist lower in the stack. In general no attempt is made to limit this, but its effect (the forced emptying of traps) is eliminated by establishing zones where no connections may be made.



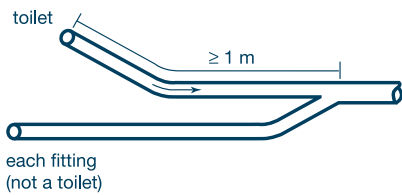

Illus. 3.9 Situation 6 from illustration 3.8.

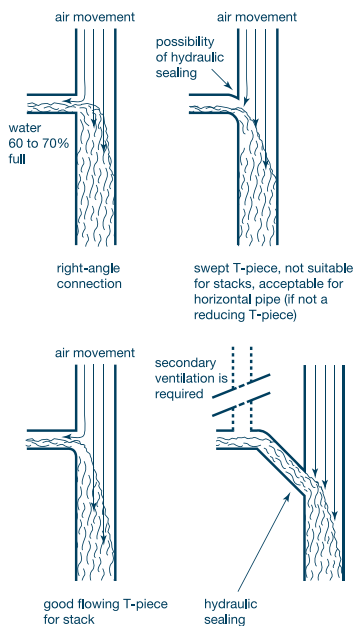

Illus. 3.10 Various connections to a stack.

### 3.4.1 Connections to stacks

#### - Method

■ Connections to the stack should be at right angles to prevent hydraulic sealing in the collecting pipes. With connections at less than 45°, pressure differences in the stack are lower but overpressure is created in the collecting pipe, which then requires additional ventilation. At high rates of discharge from the collecting pipe hydraulic sealing may occur in the stack immediately below the connection. A 90° swept T-piece may be used to reduce the likelihood of this. The precondition is that the top side is straight, otherwise the solution is contra-productive. A variety of possible situations are shown in illustration 3.10.

- Where a toilet is directly connected to the stack, it is recommended that the upper surface of the water seal is at least 100 mm higher than the underside of the pipe connecting to the stack. In the case of a connection to 110 mm that will mean that the upper surface of the water in the trap seal will be at least up to the upper surface of the connecting pipe. This prevents back-flowing foul water appearing in the pan.
- Mutual separations and angles of connection. In order to limit interactions the distance between pipes connecting to the stack must be greater than 0.5 m if the included angle is greater than 90° (illustration 3.11).

### 3.4.2 Angled sections

Angled sections must be avoided. It was previously believed that angled sections were useful in reducing the speed of fall. If an angled section is nevertheless unavoidable because of cables or other services, then the length of the branch may be 1.50 metre at most and the bends used may be a maximum of 45° (illustration 3.12).

### 3.4.3 Stack foot and connection-free zones

Overpressure is created by compression at the transition from the stack to a horizontal pipe or underground pipe.

- In order to prevent this, two 45° bends with an intermediate section of at least 0.25 metres should be used in place of a right-angle bend. This will smooth out the flow (illustration 3.13). Also noticeably less noise will be generated.
- Where a horizontal branch is required on a stack, connection-free zones should be established alongside both bends (illustration 3.13). 1 Metre connection-free zones are required for each 10 metres of stack length (between the horizontal pipe and the highest connection) where the stack joins a horizontal pipe. Where the stack length is between 10 and 20 metres the connection-free zones must be 2 metres long. Connection-free zones of 1 metre are required at the horizontal/vertical transition (illustration 3.13). The diameter required for the horizontal section is of course calculated as for common or underground piping, and the largest calculated diameter is used throughout.
- An alternative solution must be found where connections are nevertheless required in connection-free zones (illustration 3.14).

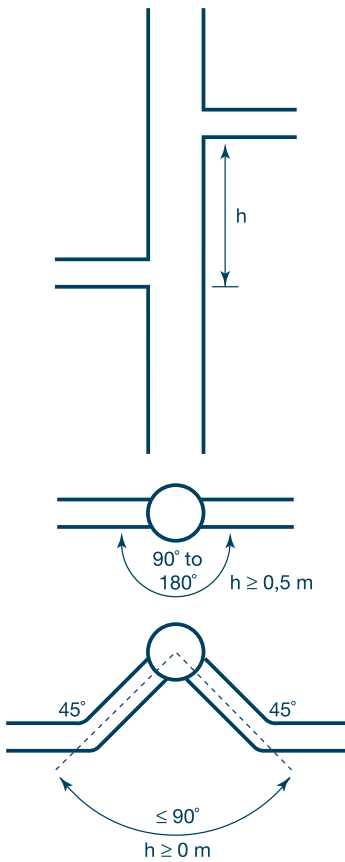

Illus. 3.11 Separations and angles for connections to stacks.

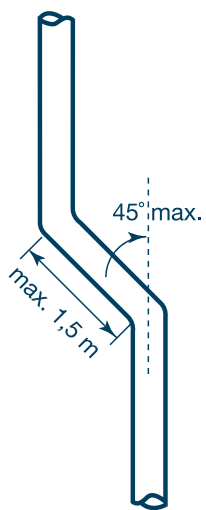

Illus. 3.12 Angled sections in a stack.

- Particularly where there are several horizontal sections in the stack a balancing line must be provided (illustration 3.15). Each vertical section must be connected to the corresponding vertical section of the stack with a downward-facing 45° T-piece. The diameter of the balancing line must be at least 0.8 times the largest diameter in the relevant stack section. Connection-free zones are also applicable here.

### 3.4.4 Stack diameter

This is calculated by taking the sum of the baseline discharges and the largest baseline discharge at the foot of the stack, using Illustration 4.2. Where the stack is connected with horizontal sections as in illustration 2.5, 3.13 and 3.15, then the diameter must be established separately for each section. A reduction by one step in size is permissible for the upper part of the stack, provided the total length of the discharge pipe plus the reduced stack is no more than 10 metres. The diameter of the reduced stack section must of course remain at least as large as that of the connection above.

### 3.5 Underground pipes

For underground pipes taking domestic waste water only, all the criteria apply as set down for stacks. Connecting pipes and stacks must be connected to underground pipes via a side connection, an oblique connection or a top connection at 45° (illustrations 3.5, 3.6 and 3.7).

### 3.6 Ventilation pipes

The ventilation pipe serves to admit and vent air to and from the discharge system.

- The diameter should be the same as that of the stack, ignoring any reduced section of stack.
- The diameter may be reduced by one step if all the following conditions are met:
  - total length of the stack is less than 20 metres;
  - length of the ventilation pipe is less than 10 metres;
  - total length of the ventilation pipe including the reduced stack section is less than 10 metres;
  - there are no more than 4 bends of 90° or 6 bends of 45°;
  - the reduction does not occur in the combined section of a ventilation pipe.
- Ventilation pipes may be horizontal.
- Ventilation pipes for several stacks may be combined into a single roof penetration provided:
  - the diameter is at least that of the largest stack;
  - the combined section is not reduced;
  - no more than 10 stacks are combined.

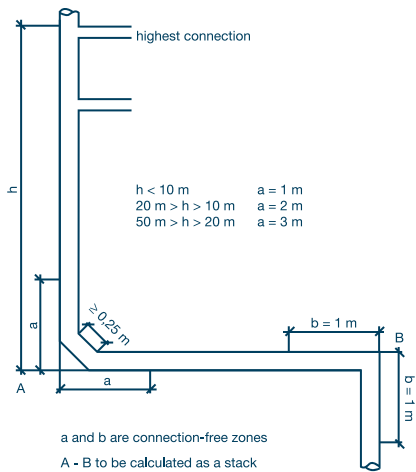

Illus. 3.13 Transition between stack / horizontal pipe and connection-free zones.

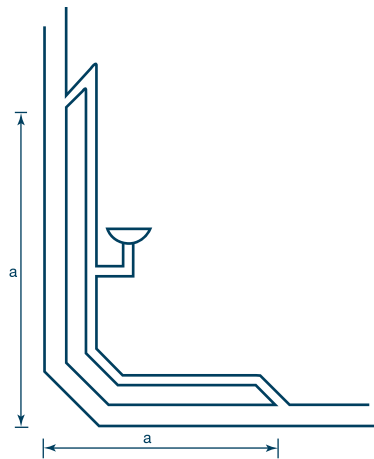

Illus. 3.14 Connection in a connection-free zone.

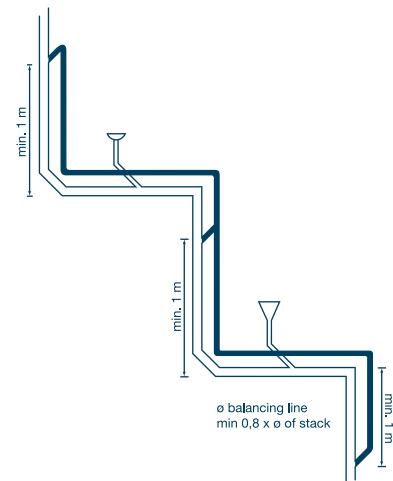

Illus. 3.15 Example of a balancing line. See also illus. 2.4 and 2.5.

### 3.7 Roof penetrations

The vent pipe is taken through the roof. A cap is usually fitted to the pipe end. Stench from the waste system may not cause nuisance. A number of requirements and conditions are set down to achieve this:

- The outlet area for the outgoing flow must have at least the same surface area as the cross-sectional area of the discharge pipe.
- The vent pipe must protrude sufficiently above the roof (to take account of snow among other things).
- The vent pipe must not penetrate a wall.
- The vent pipe opening must be at least 1 metre above the highest point of any air opening (door, roof-light, ventilation opening).
- The vent pipe must be at least 8 metres from any:
  - roof terrace or other external space;
  - air opening (door, roof-light, ventilation opening) in the wall if the roof joins a rising wall.

The foregoing will explain why ventilated roof tiles are strongly discouraged. In the case of buildings higher than 20 metres, or adjacent to buildings above that height it is possible that wind effects will create overpressure or underpressure around the vent opening. In that case the vent must be placed as far as possible from the roof perimeter or adjacent high wall.

### 3.8 Discharge of waste water

Grey or black waste water may not be discharged into the surface water or infiltrated into the ground without purification. In most cases the waste water will be led off via the local authority sewer. In certain circumstances in outlying areas where no sewer is available it may be permitted to purify the water to the extent that it can be discharged. Depending on the sensitivity of the area a simple or more advanced individual water treatment facility may be required. Such a

facility should in any event be provided with an approval mark. Grey and also black water may be so purified that it can be used as a domestic water source. Contact the local authority for more information about the possibilities and obligations.

## 4. Dimensioning for waste water

Taking account of the minimum diameters stated in illustration 1.2 the required diameters can be read off for:

- collecting pipes and underground pipes for removal of waste water (illustration 4.1);
- stacks for removal of waste water (illustration 4.2).

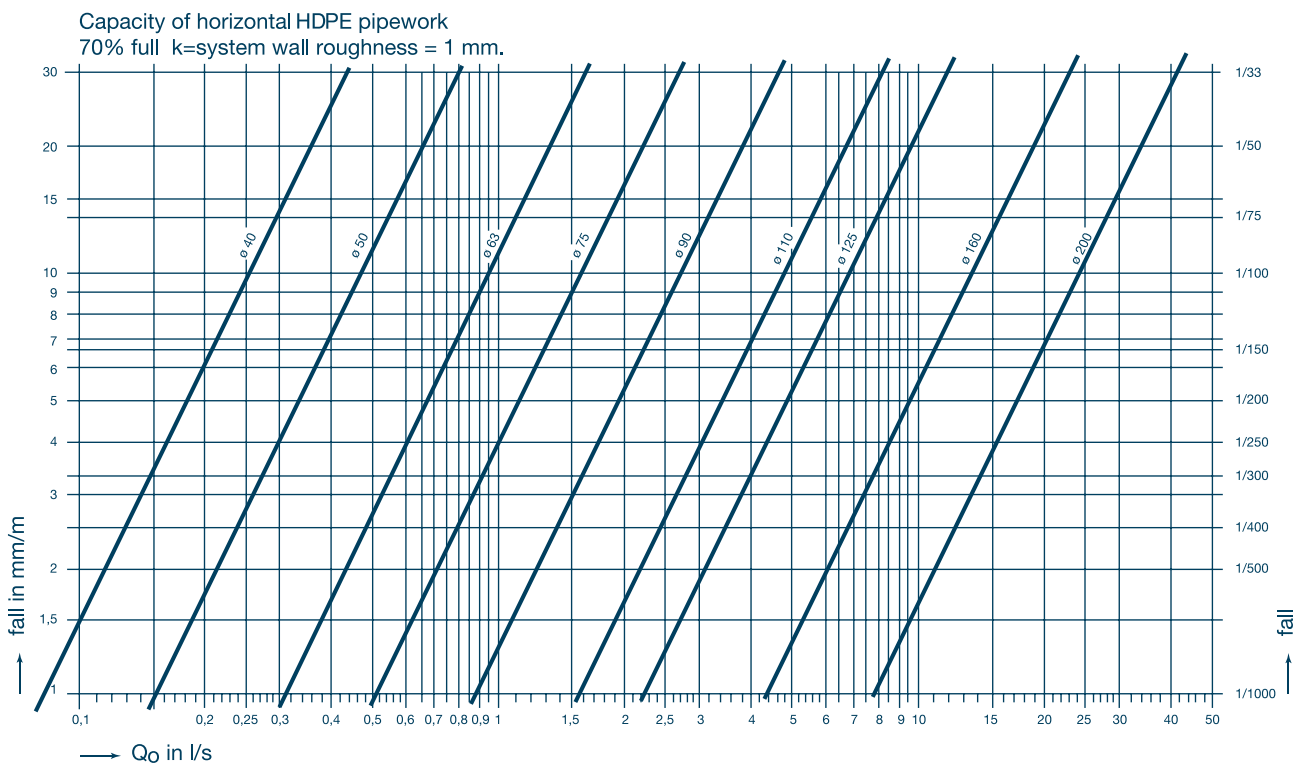

*Illus.4.1 Capacity of horizontal HDPE pipework; 70% full,  $k$  = system wall roughness = 1 mm.*

D	40	50	63	75	90	110	125	160	200
$Q_0$ in l/s	0,45	0,77	1,30	1,89	2,80	4,30	5,62	9,22	14,41

*Illus. 4.2 Capacity of HDPE stacks with a maximum pressure difference of 300 Pa (30 mm of water).*

In general, it is considered good practice to keep the noise caused by discharge, as low as possible. In the Netherlands, requirements are set for noise reduction in NEN 1070 and NPR 5075.

An optimal situation can be achieved by choosing a low noise pipe in combination with good installation practices. In living areas in an adjacent residence the level may not exceed 30 dB(A) while for educational and working areas the figure is 35 dB(A). The Wavin range includes a special low-noise waste removal system designed to meet these requirements, Wavin AS. In this chapter we investigate the generation and transmission of noise in waste pipework and the measures that can be taken to limit noise nuisance.

### 5.1 The generation of noise

Noise is generated in various ways in a pipe with flowing water: the sounds of flowing water and air, the noise of water impacting on water and of water impacting on the tube wall. Combating noise nuisance in waste pipework requires a combination of measures, the most important of which is: to prevent as far as possible that noise is generated. The design for a waste pipework installation must therefore ensure an optimal layout: little impact (so good pipe routing) with proper ventilation to ensure that the water can flow unhindered to counter bubbling and differences in flow rates. The pipe wall must be smooth to prevent irregularities in flow.

### 5.2 Noise transmission

Noise will occur even with correctly routed pipework. Transmission of noise takes place in two ways: through the air (airborne noise) and through solid bodies in contact with one another (contact noise). A heavy intervening wall is required to limit the transmission of noise through the air. The lighter the pipe wall, the more easily the airborne noise escapes to the outside. High specific

gravity and a thick wall are therefore appropriate. Contact noise is a troublesome phenomenon. All materials in contact with one another will vibrate together, little damping takes place and amplification may even occur. As the E-modulus of a material falls there is less spreading of noise. In order to reduce contact noise it is important that pipe walls do not make contact with one another or with other bodies.

ASTOLAN®, the material used to make Wavin AS combines a number of positive characteristics in a unique way: it has a low specific gravity, a thick wall and a relatively low E-modulus. The expansion compensator ensures that a Wavin AS pipe has no direct contact with the next pipe. The pipes must be secured with brackets with rubber inserts so that minimal noise is transmitted to walls and floors. These walls and floors should preferably be of substantial mass so that it is difficult to bring them into vibration. A notorious source of noise is the transition from a vertical stack to horizontal pipework. The Wavin AS range includes a variety of accessories to allow this transition to take place smoothly and few sharp changes in direction. Additionally this section is freely suspended in rubber in the Wavin AS range and there are no brackets. Even with all these measures in place waste pipework may not pass through frequently occupied areas. Try to arrange routing so that pipework is kept as far as possible away from areas that must be kept low-noise. There must be at least one intervening wall between pipework and a frequently occupied room.

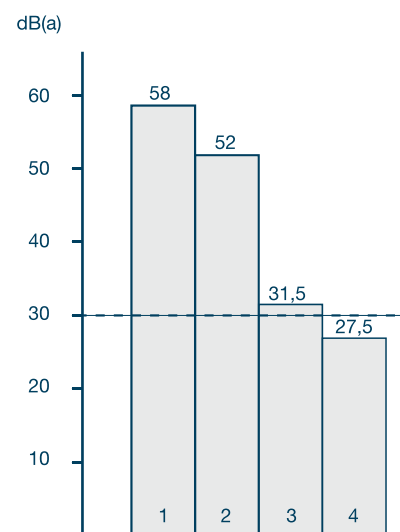

Noise from stacks

- 1 = PVC without jacketing, pipework in test area.
- 2 = Wavin AS without jacketing, pipework in test area
- 3 = PVC with cellular concrete duct (56 kg/m<sup>3</sup>)
- 4 = Wavin AS with cellular concrete duct (56 kg/m<sup>3</sup>)



## 5.3 Noise reducing measures

1. Waste pipework should not be located in the vicinity of occupied areas, and must never be led openly through occupied areas.
2. Good routing and ventilation cut down noise generation:
  - Falling waste water should be led down smoothly in stages, abrupt descents are bad from a noise point of view.
  - At the foot of the stack a calming section of 250 mm should be used at the transition from the stack to the horizontal pipework. The use of 2 bends of 45° with long legs is recommended here.
  - Waste pipework should be dimensioned so that air can circulate freely along with the waste water.
  - A gradually tapered reducer creates less noise than an inserted reducer does.
  - Connections to collecting pipework or to underground pipes should preferably be by means of side connections. Where top connection is unavoidable, then an angle should be employed.
  - At the foot of the stack the axis of the horizontal pipe can be shifted around  $1 \times D$  with respect to the axis of the stack. This allows the water to cling better to the walls creating less noise.
3. A plastic pipe wall is and remains smooth so that flows are not disturbed.
4. The special ASTOLAN® pipe wall (Wavin AS) prevents airborne noise and contact noise.
5. The Wavin AS expansion compensator prevents transmission of contact noise.
6. A rubber insert in the brackets prevents transmission to the wall, pipework must never make contact with walls or other materials.

7. Fixing to a heavy wall damps down contact noise (preferably  $> 220 \text{ kg/m}^2$ ).
8. No brackets should be located in impact zones.
9. A (heavy) intervening wall damps down transmission by air.
10. With dummy wall constructions the pipework should be secured to the bearing wall rather than to the dummy wall.
11. All wall and ceiling penetrations should be provided with rockwool or other elastic materials. This prevents direct contact between the pipework and the wall and the transmission of airborne noise from one room to another along the pipework.
12. Where a pipe duct is present, the inside of the duct wall must be provided with absorbent material (mineral wool).
13. With horizontal pipework below a false ceiling, provide extra insulation with lead foil at bends and connections.

Since the method of installation affects the generation of noise it is recommended that the installation is carried out by well-trained fitters. Where the measures outlined above are implemented consistently, no additional noise insulation will generally be required.

## 5.4 Fittings

Noise from fittings can be limited by:

- anti-vibration insulation and anti-vibration fixing of the toilet pan
- removal of reverberation by placing damping material below baths and shower trays
- reduce noise from water jets by using a small angle against the wall or by means of a perlator.

## 6. Casting in heat cured concrete and extrusion shrinkage

HDPE pipework gives excellent results when cast into concrete floors and walls (see Chapter 7, Installation). Concrete is sometimes brought to very high temperatures in order to allow shuttering to be struck the following day, particularly in tunnelling work. The temperature gauge controlling the burners may sometimes be defective. It is also sometimes the case that the control of the burners is carried out using the outermost tunnel sections, because these cool most rapidly. The temperature in the enclosed tunnel may then be appreciably higher. Extrusion shrinkage becomes significant for plastic pipework in these circumstances. Extrusion shrinkage is the single-occurrence shrinkage measurable when the pipe is heated and then cooled. The

limits are set down in the standards against set temperatures, and are for HDPE: at 110°C max. 3%.

The pipe will expand during heating of the liquid concrete. The degree of expansion is limited as the pipework is fixed at various points and (the mass of) the concrete restricts expansion. Once the concrete has hardened the pipe will shrink due to thermal shrinkage and extrusion shrinkage. This is resisted by the hardened concrete as the pipework is held fast by bends, sleeves, T-pieces and similar, so that tensile forces arise in the pipe. The tensile forces give rise to concentrations of stress which may lead to breakage. T-pieces are particularly susceptible to stress concentrations.

The degree of extrusion shrinkage depends on the maximum temperature achieved.

It is clear that the temperature of the pipes may be no higher than 80 to 90°C to cut out all risk. Since the variation in temperature in the concrete can be fairly great, it is stipulated that the measured temperature shall be no higher than 50 to 60°C. Higher temperatures are in any case not good for the quality of the concrete.

HDPE pipes for above-ground drainage are sometimes "tempered" for safety reasons. That means that they are heat treated during or following manufacture (extrusion), largely removing extrusion shrinkage.

## 7. Installation

The installation of waste pipework can be divided into the installation design and the installation itself with the actual work of fitting. The installation must be such that the pipework system can fulfil its function without problems and with the minimum of maintenance. The system must be able to handle changes in use, such as changes to the frequency of discharges or the temperature of the medium. The most important condition is that the system must be able to withstand the loading generated in installation and use. These include: loading through the contents and the weight of the pipework itself; flotation forces when casting into concrete floors and in some cases with underground pipework; forces arising from changes in length due to fluctuations in temperature. This imposes a number of requirements on the design and installation of the system.

### 7.1 Design

#### 7.1.1 Fixings

Welded connections in HDPE may be either butt welds or electro-welded sleeves.

Butt welding creates ridges on the interior and exterior of the pipe. The internal ridges can hinder the proper flow of foul water. An experienced welder will be able to make a sound welded joint with only minimal ridging. Electro-welded sleeves can be applied in critical situations.

#### 7.1.2 Brackets

Brackets must have sufficient strength to carry the weight of the complete pipework when full. Illustration 7.1 shows the suspension forces for filled HDPE pipework for various bracket separations. Brackets may have different functions: support, clamping or fixing. A support bracket serves to carry the weight of the pipework. If the pipework expands or shrinks it must be able to slide through the bracket (or the bracket must be able to follow the movement with little resistance, for example through the use of a long, slender suspension leg which will easily bend). Clamping brackets serve to fix the pipe with respect to the structure. The bracket must therefore hold the pipe securely and be attached to the structure

without excessive deflection.

This method allows any changes in length to be transferred to places where these can be dealt with by means of bends, flexible pipe, expansion sleeves and so on. With HDPE pipework systems the pipes can be fixed so that no changes in length can occur. The forces generated can be taken up by the pipework itself and transferred to the structure via fixed point brackets. We then talk about "rigid installation" with fixed point brackets. Rigidly installed pipework has a tendency to undulate. This can be prevented with the use of rails or bearers (see 7.2.2).



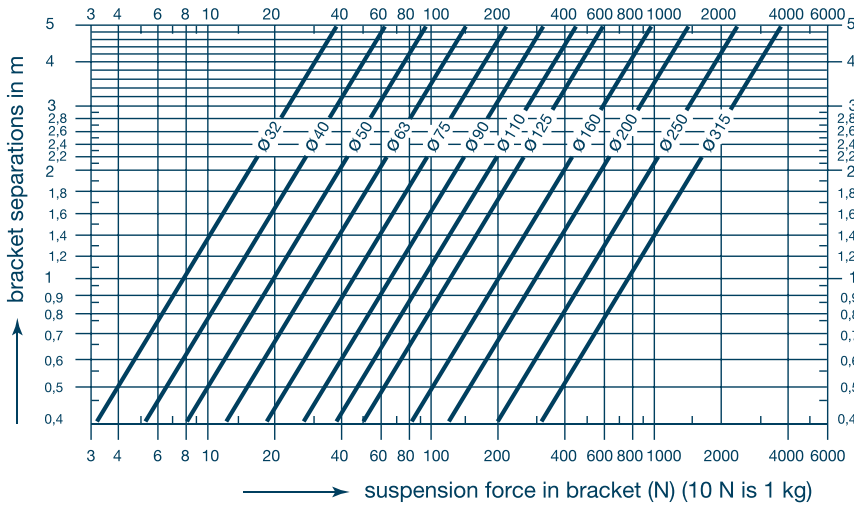

**Illus. 7.1** Relationship between bracket separations, pipe diameter and suspension forces with filled HDPE pipework.

### 7.1.3 Freely suspended pipework

- Temperature differences.  
Plastics have a fairly high coefficient of thermal expansion. For HDPE it is 0.2 mm/m °C. Pipework will therefore become longer or shorter through temperature fluctuations. Extreme temperature fluctuations may also arise during construction, from 50°C in the sun to -20°C in winter when sites shut down. Temperature fluctuations arise during use, from the varying temperature of the discharged water and of the environment. 40°C may be adopted as a maximum mean temperature difference in the walls of connecting pipes and collecting pipes for domestic above-ground drainage, even where occasional brief discharges of waste water at 80°C to 90°C occur. A 20°C temperature difference can be adopted for stacks and underground pipework. Note: This relates to the mean wall temperature along the full length of the pipework; the variation in discharge temperatures may be far greater. For extended discharge of large quantities of hot water a 60°C temperature difference may be adopted; HDPE will usually be selected for such

applications, as the medium temperature exceeds 70°C. Temperatures may vary widely for rainwater drainage under the roofs of large buildings. It is recommended that 40°C to 50°C be taken as air temperature and +5°C as water temperature in winter rain. The effective temperature difference is then around 35°C. The largest variation in temperature in rainwater downpipes on walls will arise when the water is not drained off. Large temperature differences can occur under the influence of frost and sun and a maximum variation of 60°C can be reckoned upon. Through this temperature difference pipework will become shorter or longer. Practice shows that the difference in length will be around 0.75 times what was calculated. We can distinguish between cold pipework (max. temperature difference 20°C), warm pipework (max. temperature difference 40°C) and hot pipework (max. temperature difference 60°C). These distinctions apply to domestic discharges. In the case of extended discharges of large quantities of (hot) water the categorisation should move up one place.

Hence

$$L = L \times 0.75 \times I \times T$$

L = Change in length in mm.  
L = Length between two points in m.  
I = coefficient of expansion (HDPE 0.2 mm/m °C)  
T = temperature difference in °C  
T depends on the type of pipework:  
cold pipework T = 20°C  
warm pipework T = 40°C  
hot pipework T ≥ 60°C

Modifications to the building or its use may alter the temperature range. Sufficient safety must therefore be incorporated into the building. Good routing of pipework can be of assistance here. This allows maximal freedom of movement so that the minimum tension or elongation arises in the material.

Small diameter pipework may sag when warm or hot, so that the necessary fall is lost. It is then sometimes necessary to provide continuous support to the pipework. Support with half-shell brackets is recommended for HDPE-pipework (illustration 7.8). The pipework will generally not move easily if half-shell brackets are used. This can therefore not be termed flexible installation.

### 7.2 Installation methods

The installation method is determined by the manner in which the changes in length resulting from temperature fluctuations are taken up. Two possible methods are available:

- Flexible installation, divided into:
  - flexible installation with expansion sleeves and compression sockets
  - flexible installation with flexible connectors

- Rigid installation  
The method to be employed is determined by the designer.



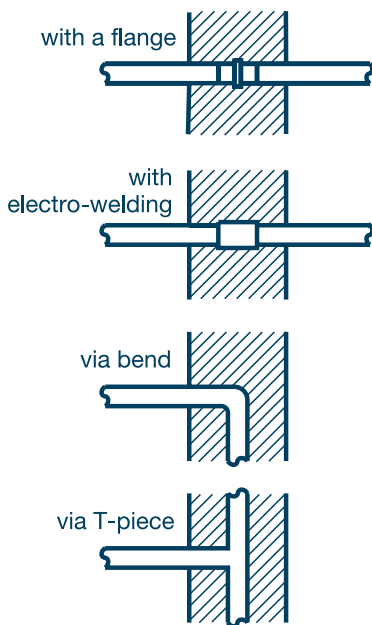

Illus. 7.2 Fixed points and fixing points via casting-in.

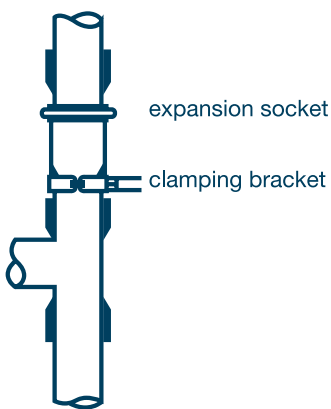

Illus. 7.3 Expansion socket at the least moveable side connection.

### 7.2.1 Flexible installation

Flexible installation means that pipe lengths determined in advance can easily be shortened or lengthened. They slide through support brackets. The change in length is taken up by expansion sleeves or flexible connectors. In order to achieve this, clamping brackets are used as fixed points at the expansion socket or flexible connector. Fixed points can also be achieved by casting-in elements of the pipework (illustration 7.2). It is recommended that expansion pieces should be used only in vertical pipework and flexible connectors in horizontal pipework.

- Flexible installation with expansion sleeves and couplers

#### ■ With expansion sleeves

There is a risk when expansion pieces are used horizontally that fouling will occur between the socket and the pipe. Use of expansion pieces is therefore recommended only in the case of vertical pipework. For the same reason expansion sockets should be fitted with the socket end upwards. Expansion sockets are fixed with fixed point brackets above which the pipe must be free to change in length. A sliding bracket is therefore generally used to support the socket. Good alignment is important. The pipework between the expansion sockets must be resistant to tensile stress. As a rule of thumb, the length between expansion sockets is generally 6 m for HDPE, provided there are no side connections. In practice an

expansion socket is provided on each storey, with the floor of each storey serving as the fixed point. In order to allow the pipe room for expansion it must not be inserted right up to the stop in the socket. The free length within the socket is dependent upon the temperature during installation. Expansion sockets are available with the insertion length stated in relation to the ambient temperature during installation. Since the socket end always points upwards it is possible that soiling will enter the socket via the pipe from outside during construction. This can be prevented by sealing the socket with tape. Expansion sockets should be placed as close as possible to the least moveable side connection. In residential properties this will be the toilet connection. The expansion socket is then located directly above the toilet connection T-piece (illustration 7.3).

#### ■ Using couplers

With HDPE pipework, if the socket is firmly attached to the pipework, the fixed point clamp must be placed by the socket. With a permissible  $L$  of 10 mm, the permissible pipe length for "cold" pipework is  $L = 10 \text{ mm} = L \times 0.75 \times 0.2 \times 20$ .  $L = 3.33 \text{ m}$ . With "warm" HDPE pipework  $L = 1.66 \text{ m}$ . With this type of pipework it is important to prevent grit entering the pipes. The sliding back and forth in the rubber seal can in time allow grit to enter between the pipe wall and the rubber seal, causing leaks.

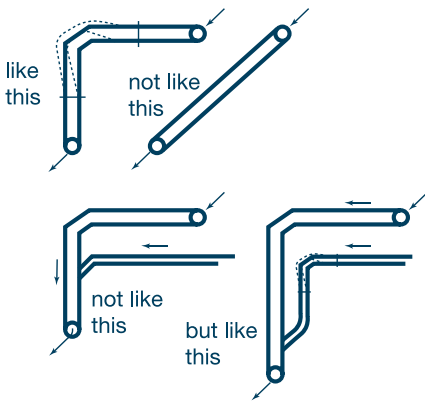

Illus. 7.4 Minor changes in alignment to create flexible pipe sections.

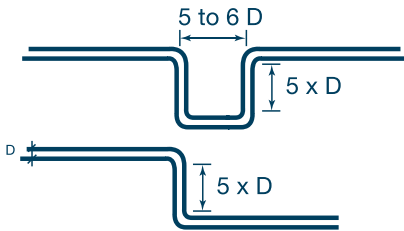

It is better to make 90° bends from 2 x 45° bends with a straight section between of at least 5 x D

Illus. 7.5 Horizontal "jump" to create flexible section in long stretch of horizontal waste pipework.

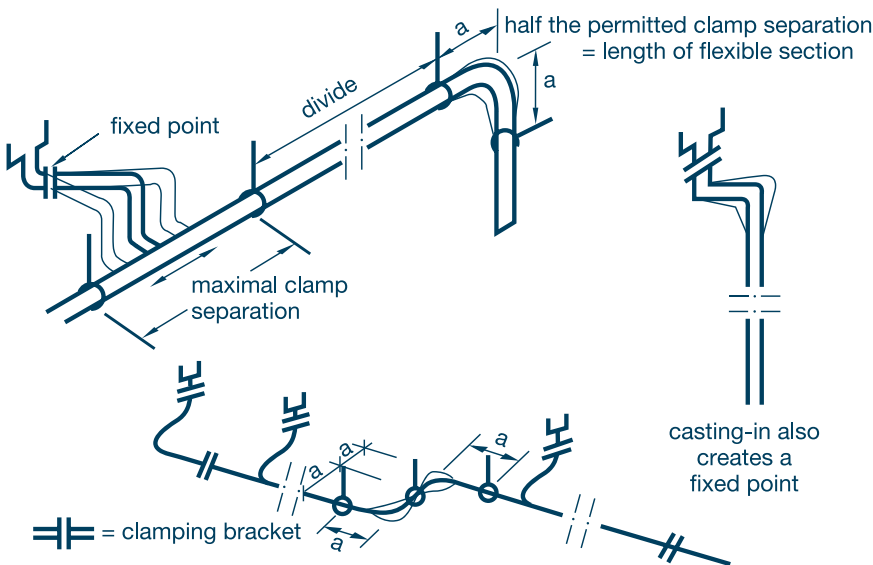

Illus. 7.6 Flexible installation with flexible connectors, and distribution of brackets.

- Flexible installation with flexible connectors

For horizontal pipework this method is preferred over expansion sockets. In general only a small change in alignment is required (illustration 7.4). For long sections of pipework it may be necessary to create horizontal "jumps" (illustration 7.5). If this is appreciated in good time there need be no difficulties with any other pipework or cables. As with expansion sockets, support brackets are used, with clamping brackets for fixed points. The permissible pipe length from the fixed point (clamping bracket) to the flexible section is dependant on the bending the flexible section can take. The pipes should be bent so as to provide the maximal flexible length. This gives clarity in assembly and maximum flexibility. Halving the permissible clamp separation distance will give the permissible length for the flexible section (illustration 7.6).

Apart from brackets at fixed points, all brackets must be support brackets. Another solution is to select (threaded) support clamp suspension legs of materials and dimensions that will bend to follow the changes in length. This does however open the way to undulation of pipework. This last point need not present a functional problem provided the fall is not reversed. It is however often regarded as less pleasing to the eye. The change in length (L) for a particular length of HDPE pipework and the required length (L) of a flexible section for various temperature differences can be read off from illustration 7.7.

- Bracket separations with flexible installation

Clamp separations are selected so that the pipe does not sag enough to prevent proper emptying even when hot water is carried. The pipework must still be able to slide through the support brackets. The pipework must also be prevented from excessive sagging for aesthetic reasons. From strength point of view horizontal pipework in HDPE can be suspended with clamp separations from 20 to 25 x D.

HDPE waste pipework can be installed with or without half round shell brackets (illustration 7.8). The shell brackets are in galvanised steel and may be black. Shell brackets are used with horizontal pipework where neat, straight runs are required, without sagging. With "hot" pipework ( T = 60°C) shell brackets are necessary with HDPE pipes. Shell brackets are often used with small diameters to allow a greater separation between brackets. Since the pipe cannot easily slide through the shell brackets, rigid mounting is always used with half-shell brackets (see 7.2.2).

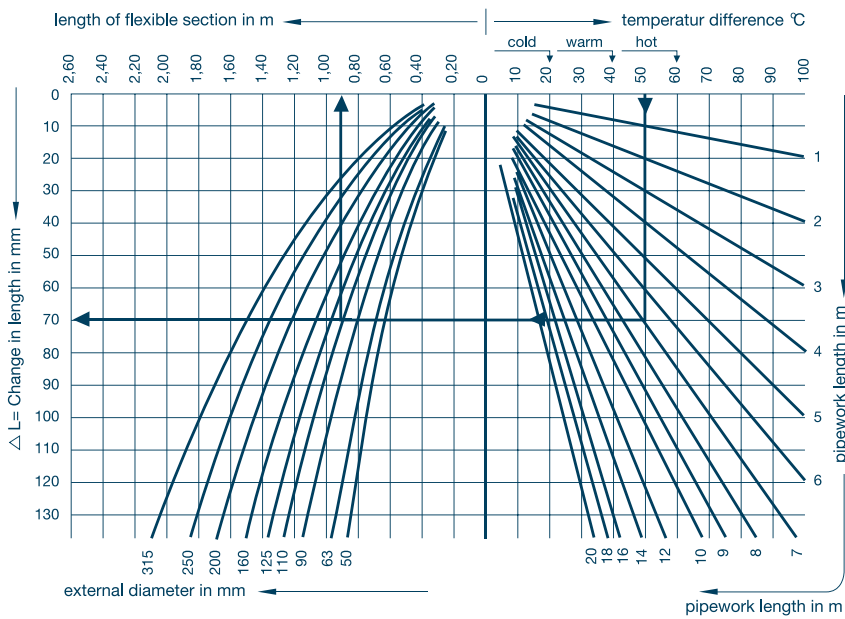

**Illus. 7.7** Relationship between temperature difference, freely moving pipework length, changes in length and length of flexible section for various diameters of HDPE pipes.

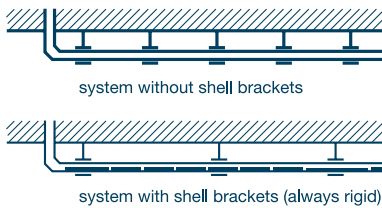

**7.8** System without/with shell brackets.



- Bracket distribution with flexible installation

■ **With expansion sockets**

With expansion sockets the clamping brackets must always be located at fixed points. The distance between these is divided, taking account of the maximal bracket separation, and the support brackets placed accordingly.

■ **With flexible connectors**

The brackets are to be placed at the maximum permitted distance from the nodes (branches, bends etc), see illustration 7.6. The distance between these is divided, taking account of the maximal bracket separation.

**7.2.2 Rigid installation (HDPE)**

In the case of rigid installation the system is installed in such a way that changes in length cannot occur. The forces generated are transferred to the building structure by shell brackets, fixed point brackets and suspension constructions. Rigid installation is only required with HDPE. A rail system or half-shell bracket support system is always required with rigid installation. With shell brackets alignment is achieved by securing the pipe to the shell bracket at the location of the 0.2 metre overlap, using a clamp or 2 strong Tie raps. The pipe is also fixed to the shell brackets every 10 x D (min. 0.5 m; max. 1 m) with Tie raps or bands.

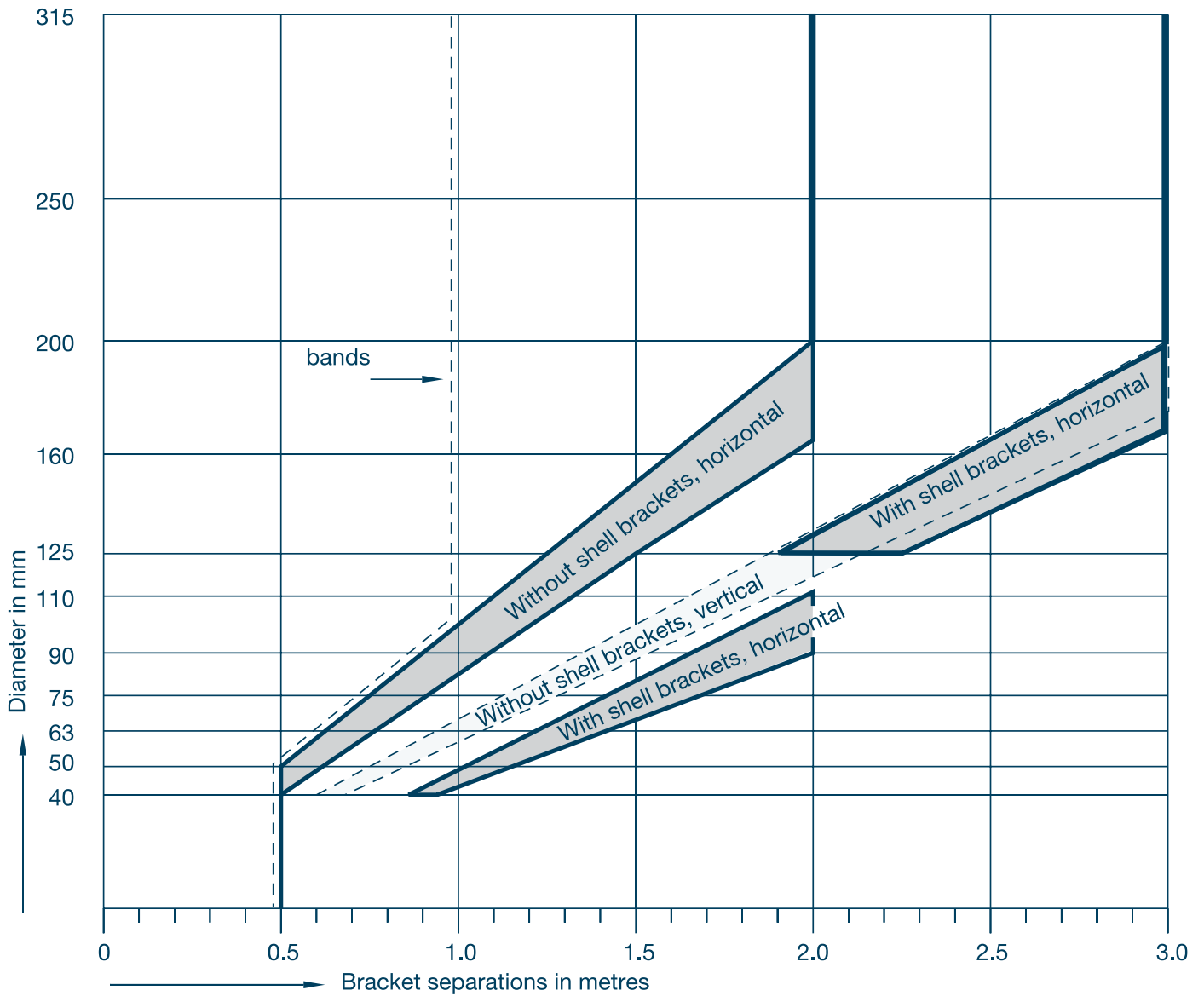

Brackets: horizontal without shell brackets: 10 à 12 x D; min. 0.8; max. 2 m  
 with shell brackets: ≤ 110 mm: 18 à 22 x D; max. 2 m  
 ≥ 125 mm: 15 à 18 x D; max. 3 m  
 vertical: without shell brackets: 15 à 17 x D; max. 3 m

Bands:  
 10 x D; min. 0.5 m; max. 1 m

Illus. 7.9 Bracket and band separation for HDPE waste pipework, flexible installation.

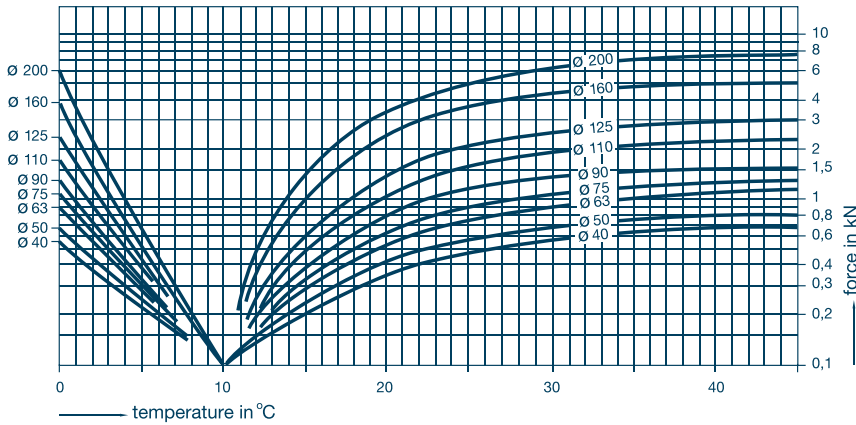

**Illus. 7.10 Rigid installation. Forces occurring in the pipe at particular temperatures assuming a temperature during assembly of 10°C.**

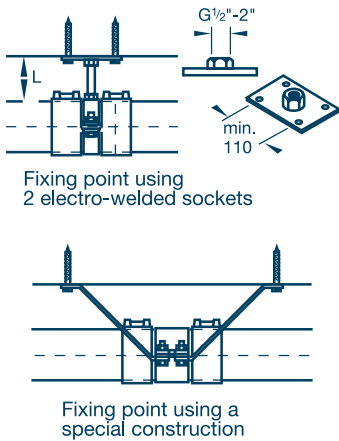

**Illus. 7.11 Fixed point construction possibilities for rigid installation using HDPE in diameters > 160 mm. Also possible as a fixed point in flexible installation.**

The change in length undergone by the pipe is directly proportional to the temperature difference. The force required to restrain this change in length is dependent on the cross sectional area of the pipe but also on the modulus of elasticity of the material as altered by higher temperatures. Illustration 7.10 shows the forces occurring at particular temperatures, assuming assembly free of tension at 10°C. Account has not been taken of the effect of relaxation of the HDPE material, which reduces the forces involved.

- Brackets for rigid installation  
 Where the forces of expansion cannot be transferred through a rail system (up to 160 mm) or bracket system (up to 75 mm), they must be transferred to the building structure by the fixed point brackets. Apart from using walls and floors to which the pipework can be fixed, (see illustration 7.2) fixed points can be provided using special fixed point brackets. Brackets can also be fitted between two welded sockets attached to the wall or another bearer via a threaded rod or gas pipe (illustration 7.11). It will be clear that as the length of the leg increases it must be more rigid to take

up the bending forces. Illustration 7.12 shows the diameter of threaded bracket leg required for fixed point brackets with a particular bracket leg length and pipe diameter. Since the effect of force is felt most at the nodes and in particular at changes of direction, in practice, where bracket leg lengths are short, very strong, rigid fixed point constructions are often used at the nodes only. The intervening suspension points are then implemented as fixed point brackets, but with rather longer threads. The underlying idea here is that the bracket only needs to prevent buckling.

- Clamp separations with rigid installation  
 The fixed point brackets must be fixed at every node and further every 5 to 8 metres, depending whether it is hot, warm or cold pipework. Every 6 metres are regarded as standard. For the intervening brackets which are used as clamps, the separation distances provided for shell brackets in illustration 7.9 are used.

**7.2.3 Cast-in pipework**

Pipework cast into concrete can be regarded as rigidly installed. Any welded joints in HDPE must be allowed to cool first. It is recommended that the pipework is pressure tested and checked for leaks before the concrete is poured. The pipework must be well fixed to prevent flotation during pouring. Special brackets are available for this purpose (illustration 7.13). With HPE the bracket separation is around 8 x D (min. 0.75 metre, max. 1.5 metre). If pipework is cast vertically in concrete (e.g. columns, walls) the liquid concrete will produce an external overpressure. Illustration 7.14 shows the resistance of various classes of HDPE pipes to external overpressure in kPa at 30°C. (SDR = external diameter/wall thickness)

Note: The calculated class does not always accord with the nominal class.

In order to calculate the external overpressure in kPa the height in metres of liquid concrete must be multiplied by 24. If the pipe is filled with water to counteract flotation the multiplication factor is 14.

Example: 6 metres of liquid concrete, pipe Ø 110 mm without water filling, pressure  $6 \times 24 = 144$  kPa. Minimum required for HDPE:  $110 \times 34$ .

With water filling the external overpressure is  $6 \times 14 = 84$  kPa. In HDPE SDR 26 will suffice.

Length threaded bracket leg mm	Pipe diameter								
	40	50	63	75	90	110	125	160	200
100	1/2"	1/2"	3/4"	3/4"	3/4"	1"	1 1/4"	1 1/4"	1 1/4"
150	3/4"	3/4"	1"	1"	1"	1 1/4"	1 1/4"	1 1/2"	1 1/2"
200	3/4"	1"	1"	1"	1"	1 1/4"	1 1/2"	2"	2"
250	1"	1"	1"	1 1/4"	1 1/4"	1 1/2"	2"	2"	2"
300	1"	1"	1 1/4"	1 1/4"	1 1/4"	2"	2"	-	-
350	1"	1 1/4"	1 1/4"	1 1/4"	1 1/2"	2"	2"	-	-

Illus. 7.12 Required threaded leg diameter for a given pipe diameter, and maximum bracket leg length for fixed point brackets with rigid installation in HDPE waste removal system.

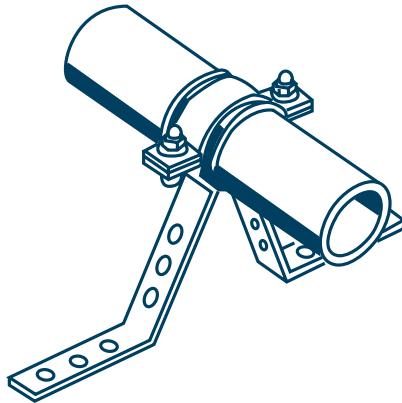

Illus. 7.13 Bracket for casting-in HDPE in concrete.

HDPE				
SDR Du/e	HDPE pipe size			calculated resistance (kPa)
13,3	40x3			635
17	50x3;	63x3,6;	75x4,3	348
	90x5,1;	110x6,3;	125x7,1	
	160x9,1;	200x11,4		
21	63x3			178
	75x3;	90x3,5;	110x4,3	
26	125x4,9;	160x6,2;		92
	200x7,7			
30	90x3			58
32	110x3,5;	125x3,9;		50
	160x5,0;	200x6,2		

Illus. 7.14 Resistance to underpressure (=external overpressure) of HDPE pipes at a mean wall temperature of 30°C.

As well as the design of the installation there is also the actual assembly. The design is complete, but many decisions remain to be taken by the fitter which will impact on the quality of the work and the problem-free operation of the waste removal system.

### 8.1 General

#### 8.1.1 Pipework in the waste removal system

The pipework must be installed with a particular fall as indicated on the drawings using brackets, bands and supports. They must not be fitted horizontally, but there must not be too great a fall. Excessive fall leads to the complete closure of the pipe and to poor ventilation. Where reducing pieces are used the top of the pipework should be at the same level. The desired installation method must be known (see 7.2).

#### 8.1.2 Brackets

All types can be used with support brackets; from light nylon band brackets, light or heavy PVC brackets to galvanised sewer brackets, and suspension bands. Ensure that any sliding brackets do actually slide (avoid over-tightening). Brackets used for clamping must be strong. For fixed point brackets (only with HDPE) galvanised steel brackets must be used.

#### 8.1.3 Storage

Rubber O-rings must be kept in a cool and dark place and not exposed to sunlight (not even behind glass). Pipes must be stored as flat as possible to prevent sagging. It is difficult to produce neat, straight work with bent pipes. Keep pipes as clean as possible; this saves time when preparing and making connections. Covering is recommended during extended storage outdoors. Ensure that HDPE pipes, and particularly the ends, do not take on an

oval shape. Oval pipes create extra work when welding joints. Bear in mind that pipes can get very hot in the sun. Once out of the sun they will shrink again. If the pipe is at 70°C and the temperature inside is 20°C, a 5 metre long HDPE pipe will be  $0.2 \times 50 \times 5 = 50$  mm shorter. Leave accessories in the packaging as long as possible. HDPE electro-weld sleeves should be stored indoors and left as long as possible in the packaging to prevent oxidation from sunlight. Oxidation on the interior can badly affect welds.

#### 8.1.4 Oval pipe ends

Excessively oval shape HDPE pipe ends should first be made rounder. This can be done by clamping the pipe with one or two brackets with one or two pieces of padding between, placed a little back from the eventual coupling insertion depth at the end of the pipe. The brackets are only removed after the weld has cooled.

#### 8.1.5 Shortening pipes

The best and simplest method is to use a proper pipe cutter. The cut is then straight and no burrs are generally created. If a saw is used, care needs to be taken to ensure that the cut is straight: mark the cut, use a stiff saw blade and use a saw horse with  $\varnothing$  above 50 mm. Remove internal and external burrs with steel wool or a knife. For sawing HDPE use a fairly coarse-toothed blade with a wide set.

### 8.2 Joints

Joints fall in principle into two categories, those resistant to tension and those not resistant to tension. Welded and flanged joints are resistant to tension. Expansion sockets and connections using rubber seals are not resistant to tension.

#### 8.2.2 Joints in HDPE

HDPE pipes can not be joined using solvent cement as PVC can. However welding of HDPE gives excellent results. This creates a

tension-resistant connection. There are two methods of welding: hot plate welding and electro-welding using fittings with integral heating elements. Flange joints are also resistant to tension, but this technique is very rarely used in above-ground drainage work. Rubber O-ring joints are found in insertion couplings and expansion sockets in HDPE.



#### ■ Butt welding

Both pipe ends are placed against a hot plate at a constant temperature and pressure. The plastic pipe ends are now pressed together so that the molecules of the material are transferred between them. Wavin HDPE pipes and accessories can be hot plate welded with good results. Hot plate welding creates small ridges inside and outside the pipe. It is recommended that a training course should be followed. Before starting with hot plate welding the equipment should be checked over.

- The hot plate temperature should be 210° C.
- The hot plate must be clean and free of grease; clean as necessary with a clean cloth and alcohol.
- Ensure that the two pipe brackets and the two pipe supports are correctly aligned. This can be achieved by clamping 1 section of pipe in both clamps and both pipe supports. If necessary adjust the two pipe supports until they are correctly aligned with the pipe.
- Both pipe clamps must be adjusted so that they hold the pipe tightly



1. Check that the hot plate is up to temperature.

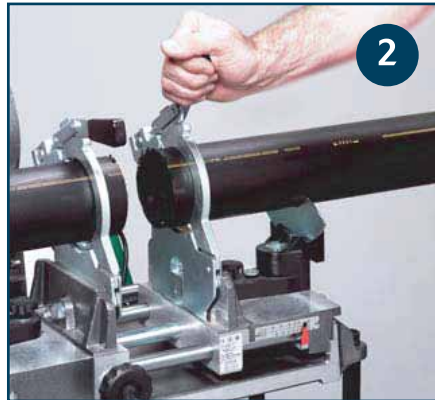

2. Clamp the pipes and use the trimmer on the ends. Stop the trimmer only when the pipes no longer contact the blade; this prevents "hooking".



3. Check that the pipe ends match precisely. If necessary clamp and trim again.



4. Press the pipe ends against the hot plate by briefly applying a high pressure. Continue heating with very low pressure until an upstand of 1 mm has formed.



5. Quickly remove the hot plate and slowly increase the welding pressure (see the table on the machine for the welding pressure).



6. Hold the welding pressure steady and allow the weld to cool.

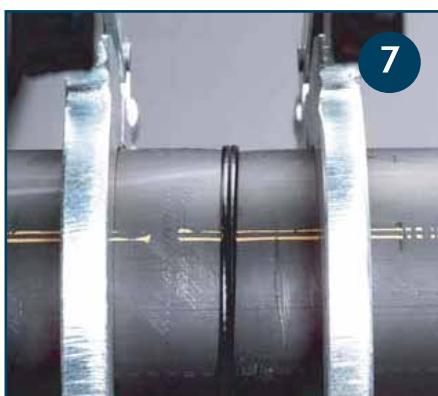

7. Remove the joint and inspect the weld. An irregular weld seam should be rejected.

**Before welding:**

- A. The hot plate temperature should be 210° C.
- B. The hot plate must be clean and free of grease; clean as necessary with a clean cloth and alcohol.
- C. Ensure that the two pipe brackets and the two pipe supports are correctly aligned. This can be achieved by clamping 1 section of pipe in both clamps and both pipe supports. If necessary adjust the two pipe supports until they are correctly aligned with the pipe.
- D. Both pipe clamps must be adjusted so that they hold the pipe tightly enough to withstand the force of the welding process. The pipe clamps can be used to make an oval pipe round (but they will also do the opposite). The tension must therefore not be either too high or too low.

**Most important data for hot plate welding of waste pipework:**

warming up time (at very low pressure)	ridge height (up to 160 mm)	welding pressure application time	cooling with welding force applied
45 - 70 sec	1mm	5 - 6 sec	6 - 10 min



enough to withstand the force of the welding process. The pipe clamps can be used to make an oval pipe round (but they will also do the opposite). The tension must there fore not be either too high or too low.

Welding itself is carried out as follows:

1. Check that the hot plate is up to temperature.
2. Clamp the pipes and use the trimmer on the ends. Stop the trimmer only when the pipes no longer contact the blade; this prevents "hooking".
3. Check that the pipe ends match precisely. If necessary clamp and trim again.
4. Press the pipe ends against the hot plate with a brief application of high pressure, then continue with application of very low pressure until a ridge of 1 mm has formed.
5. Quickly remove the hot plate and slowly increase the welding pressure (see the table on the machine for the welding pressure).
6. Hold the welding pressure steady and allow the weld to cool.
7. Remove the joint and inspect the weld. An irregular ridged seam should be rejected.

### ■ Electrical spigot welding

HDPE accessories are provided with spigot ends to allow butt and sleeve welding. The spigot ends are provided with low irregularities (ribbing) and the



welding sleeve has projections to allow their exact distance apart to be determined. This is particularly important with prefabrication. Welding equipment is required.

Also required are:

- A pipe cutter or a saw with teeth set wide.
- Clean, lint-free cloths or white crepe paper (not printed).
- Emery cloth, grit 40.
- A scraper or knife for de-burring.
- Felt tip pen or crayon.
- Tape measure or ruler.
- The electro-weld sleeve.

The HDPE electro-weld sleeve is provided with 2 socket ends which can be welded in a single operation. The welding equipment sends current through the resistance wires in the electro-weld socket for a set period. Both electro-weld sockets are welded at the same time. The electro-weld socket has stops on the interior. In order to use the socket as a slide-on collar the stops can easily be removed with a knife or screwdriver. The socket has two contact pins on the outside for connection of the welding equipment. There are also two welding indicators which appear during and after the welding operation. These indicate that the welding temperature has been reached and that the welding pressure has been applied. They do not however give any indication of the quality of the weld. The quality of the weld is dependent on a great many other factors. See "Principles and Preparation".

### ■ Principles of electro-welded sockets in HDPE

During welding the surface of the interior of the socket and the exterior of the pipe are brought to a plastic state. Expansion of the pipe and shrinkage of the socket (the shrinkage is built in during manufacture) fuse the

plastic layers together. However this is only possible if the HDPE surface is completely free from contamination. Pipes in storage develop an oxidised layer in production and storage which impedes welding. This must be removed before welding by cutting, scraping or abrasion, followed by cleaning. Furthermore the material must be free of moisture and must not move during and for a brief period after the welding. If these conditions are not met there will be adhesion but without fusion. The weld will be weaker and high loading or bending may later cause leaks. In order to achieve an even weld all round the pipe must be stress-free. Bent or oval pipes may require support. The components to be welded must be fixed with respect to one another, particularly when welding accessories and short sections of pipe.

### ■ Preparation work

Select the appropriate welding equipment. Check that the welding equipment is suitable for the diameter to be welded. The welding equipment must be protected from moisture and dirt. The voltage required is 220 Volts. In case of doubt the welding time can be checked. Full instructions for use should be provided with the welding equipment.

Welding equipment, tools and pipework components must be in good condition. That means:

- The welding equipment must be regularly inspected and the welding time must be correct.
- The contact shoes on the welding cables must not be oxidised.
- The contacts on the electro-weld sockets must be clean.
- The pipe end to be welded must not be excessively oval.
- The cloths used must be clean and lint free.

- The pipe end must be free of burrs.
- If a spigot end is very dirty it must first be cleaned with HDPE cleaner. If this is not done the dirt will be ground into the pipe when it is abraded later.
- A layer must be removed from the spigot end. This is always required!! HDPE oxidises in air and in light. The oxidised layer must be removed to achieve an optimal weld. The oxidised layer can easily be seen after extended storage in the open air. Extra care will then be required. The outer layer is best removed by abrading with clean emery cloth, grit 40. Remove the abraded particles.

The following points are also significant:

- Electro-weld sleeves have a short insertion depth, so that a pipe which is not cut square will weld poorly and provides a risk of fire.
- Check the fit between sleeve and spigot end. If this is oval refer to "Oval Pipe ends" (8.1.4).
- The pipe and fitting must not move during welding and cooling. If necessary fix with clamps. If the pipe or fitting sags or creeps the welding threads in the sleeve may sag inward. This may cause a fire.
- With large installations a powerful stream of air may flow through the pipework which can act as a flue. This may cause appreciable cooling to the interior. The pipework should therefore be sealed with a protective cap.
- The exterior of the electro-weld socket will become warm only after welding has commenced. The joint may only be loaded after the socket has cooled.
- The ends of pipes and fittings must be bone dry. If necessary pre-heat to prevent condensation.

### ■ Welding procedure

A user manual describing the welding procedure should accompany every item of welding equipment.

- First connect to the power.
- The "voltage" indicator lamp will illuminate. If the lamp flashes check voltage and connections.
- Attach the connector cables to the electro-weld socket. Note: for safety reasons these cables must not be extended.
- The "connection" indicator lamp will illuminate.
- Press start button. The welding indicator lamp will illuminate. Once welding time is complete this lamp automatically extinguishes and the current supply switches off.
- Check the weld indicators. They should have emerged by around 2 mm.

Note 1: If the welding indicator lamp flashes the welding process has been interrupted for one reason or another. Identify and rectify the cause, allow the joint to cool completely (1 hour) and repeat the entire procedure.

Note 2: The welding process may only be interrupted by switching off the supply.

If the use of an isolating transformer is required for safety reasons, say in a damp area, then this may be done without problems. Extensive testing has shown that this does not affect the weld quality.

### ■ Use of non-standard pipe

Electro-weld sockets are designed for use with HDPE waste pipes from KOMO series I and II (see table in Illustration 7.14). Pipes with thicker walls may also be welded using the electro-weld socket. Liaison with the supplier would then be recommended, since varying tolerances and greater rigidity

of pipe ends may call for modified processing.

### ■ Rubber seals

Two types of rubber seal are in use with HDPE waste systems.

- 1 With a round O-ring:
  - The O-ring housing and the ring itself must be clean.
  - The HDPE pipe must be cut square, bevelled off at around 30° and deburred.
  - Introduce the components to one another, up to the stop.
- 2 Sealing sleeve connection:
  - The sleeve and the chamber behind it must be clean.
  - Apply Wavin lubricant to the sleeve.
  - Insert the deburred, square cut and bevelled pipe.

### ■ Expansion sockets

Unlike the twin sockets used with PVC, expansion sockets in HDPE are in a single piece into which the pipe is inserted. A rubber sleeve is used as a seal.

- Install expansion socket at previously determined locations and use brackets as for a fixed point.
- With the socket end facing upwards in vertical pipework.
- Attach the HDPE pipe firmly to the spigot end of the expansion socket (using a welded joint).
- Align the expansion socket and pipework correctly at both ends. Fit an extra support bracket if required. The pipe end to be inserted must be correctly bevelled (min. 4 mm, 15°).
- Apply Wavin lubricant to the rubber ring and the end of the spigot.
- Where a stack is to be enclosed in a duct, protect the joint from materials like mortar that might fall in.
- Temperature indications appear on the outside of HDPE expansion

sockets. The pipe must be inserted into the expansion socket up to the temperature indication point for the then prevailing ambient temperature (measure and mark on the pipe).

- The following maximum lengths apply to pipe sections between 2 expansion sockets: "cold" pipework 13.2 metre; "warm" pipework 6.6 metres and "hot" pipework 4.4 to 5 metres (see also flexible installation with expansion sockets 7.2.1).

Ambient temperature	Table showing insertion depths for pipe of length 5000 mm								
	ø63	ø75	ø90	ø110	ø125	ø160	ø200	ø250	ø315
	Insertion depth in mm								
-10°C	60	60	65	70	75	90	100	115	135
0°C	65	65	75	80	85	100	110	125	145
+10°C	75	75	85	90	95	110	120	135	155
+20°C	85	85	95	100	105	120	130	145	165

*Illus. 8.1 Insertion depth for HDPE expansion sockets with "hot pipework" for a range of ambient temperatures.*

Illustration 8.1 may also be used to determine the insertion depth.

## 9. Situations during construction

Fouling, damage and movement of the installed waste removal system must be avoided during construction.

Possible measures include:

- Closing off pipework with protective caps. Use caps that fit over the pipe wherever possible so that they are not accidentally left in place. When using caps that fit within pipes, this should be clearly indicated.
- Seal off spigot ends that are still to be connected (by insertion, welding or cement).
- Expansion socket sleeves in vertical pipework should be protected from materials such as mortar that might get into the sleeve.
- Protect around 20 mm of pipe ends emerging vertically from concrete floors by sealing with plastic foam or similar prior to pouring concrete. This often prevents damage when the floor is worked on later.
- Ensure adequate anchoring to prevent flotation or bending of pipes during concrete pouring.
- Check direction and height of pipework before ceilings or ducts are installed.

- Pressure test pipework before pouring concrete.
- Prevent grit from roofs entering waste pipework. This can be extremely difficult to flush out and can give rise to problems especially with rubber seals.
- Lead rainwater out of the building as quickly as possible (illustration 9.1).

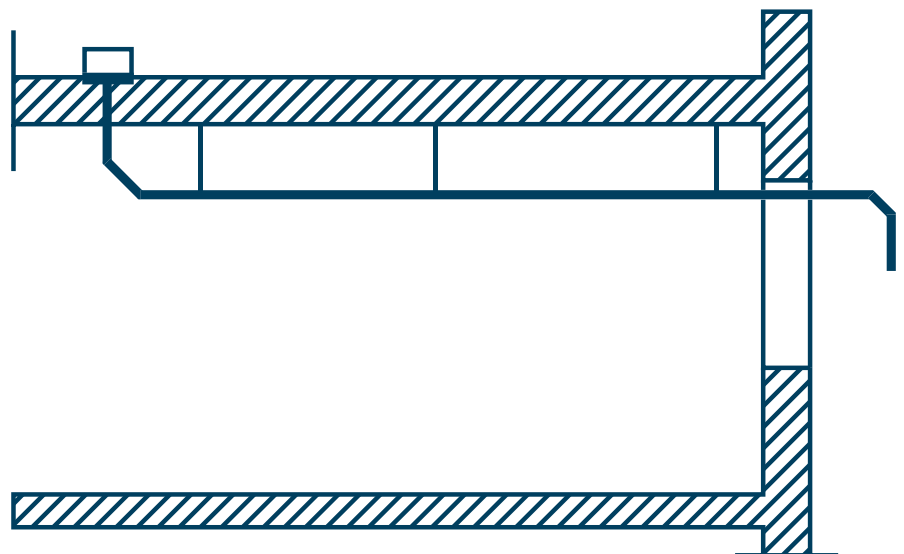

*Illus. 9.1 Temporary situation during construction.*

Pressure testing is carried out most quickly and simply using air under a limited overpressure. This is also possible with internal rainwater systems. The simplest procedure is to close off all openings, apply air pressure of 2 to 3 kPa (0.2 to 0.3 metre water column) and apply soapy water to the joints. Specialised companies sometimes use smoke-testing.

It is recommended that sections to be cast in concrete be pressure tested before pouring. This is not only because repairs are so difficult afterwards, but also to establish whom is to bear the cost of any subsequent repairs. If it is decided to carry out pressure testing (to NEN 3215) then the procedure is as follows:

- The system is pressure tested with an air pressure of 400 Pa (40 mm water column). Where the total capacity of the system to be tested is greater than 0.3 m<sup>3</sup>, then it must be tested in sections of 0.3 m<sup>3</sup>.
- All open joints are to be sealed with ball-type valves and all traps are to be filled.
- After 15 minutes the drop in pressure must not exceed 50 Pa (= 5 mm water column). If the drop in pressure exceeds that, the test must be continued up to 60 minutes. After that period the drop in pressure may not exceed 200 Pa (= 20 mm water column).
- The drop in pressure may be caused by moving connections, such as toilet sealing sleeves and sealing sleeves between horizontal pipes and connecting pipes, as well as by temperature differences during the test.
- The temperature difference may be up to 0.3°C, measured in the spaces occupied by the waste pipework.
- The pipework must not be exposed to radiant heat, including the heat of the sun.
- Where this nevertheless occurs (usually prior to pouring of concrete) then pressurisation with air and soap testing of the joints is a good alternative.
- A test is carried out immediately prior to the pressure test in order to demonstrate that the equipment is in good order. For this purpose the internal pressure in an enclosed pipeline or hose of say ø10 mm and 2 metres in length, with the pressure meter attached, is brought up to 400 kPa. The pressure drop may not exceed 10 Pa (1 mm water column) in a period of 15 minutes. When that is the case the waste removal system may be placed under pressure and the actual test carried out.

A well-designed, properly installed and correctly used waste removal system will require little or no maintenance.

Inadequacies in design and installation, and above all incorrect discharge activities may cause poor or slow removal of water or a blockage. Usually no action is taken until the water begins to drain slowly or there is a complete blockage.

Checks on drainage and periodic maintenance are therefore recommended.

In the event of blockages or threatened blockages which are not located in the traps, a clearing spring may be used. Care must be taken to prevent damage, especially in bends. High pressure cleaning with a jet head is a better approach. The use of explosive charges to cause pressure shocks in the pipes is not recommended.

The usual drain-clearing agents may be used provided the instructions on flushing are followed.

Roof channels, roofs, roof gullies and the like should be periodically cleared of dirt, leaves etc.

Specialist firms may carry out major maintenance or the clearing of serious blockages. It is useful to build in a number of cleansing facilities to aid cleaning or removal of blockages:

- removable traps
- connections to underground pipes with rubber sleeves
- access fittings at strategic points such as at the transition from underground pipework to the domestic pipework, around hydraulic problem areas such as after a series of bends and with longer pipe runs, and in cast-in pipework.

Access fittings must be accessible and where possible be located higher than the horizontal pipework, or better still higher than the discharge level of fittings.

This means that a section of the blocked pipework does not need to empty through the opened access fitting. Where the access fitting cap is more than around 100 to 150 mm from the exterior of the pipe, the use of a 45° fitting is recommended. Obstruction of drainage from roofs, gutters, gullies, overflows, rainwater drainage and other drainage constructions must be prevented by means of periodic maintenance. Special attention must be paid to drainage where granular roof coverings are installed after the drainage system is in place. Grit which enters horizontal pipework is difficult to flush away using the normal speed of flow, and encourages fouling. Flushing clean before handover and after around a year is strongly recommended.



## Product List

Art.nr.	d1	di	S1	L	A cm <sup>2</sup>
920 002	32	26,0	3,0	5000	5,3
920 003	40	34,0	3,0	5000	9,0
920 005	50	44,0	3,0	5000	15,2
920 007	63	57,0	3,0	5000	25,4
920 008	75	69,0	3,0	5000	37,3
920 009	90	83,6	3,5	5000	54,1
920 010	110	101,6	4,2	5000	81,0
920 011	125	115,4	4,8	5000	104,5
920 013	160	147,6	6,2	5000	171,1
920 015	200	187,6	6,2	5000	276,4
920 017	250	234,6	7,7	5000	432,0
920 019	315	295,6	9,7	5000	686,0

### Pipes

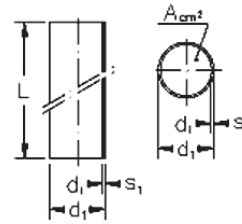

### Pipes:

From Ø 75 to Ø 160 pipe series S12,5

From Ø 200 to Ø 315 pipe series S16

Nominal diameters according to EN 1519

Hepworth PME standard pipes are supplied in standard 5 meter lengths.

Art.nr.	d1/d2	X1	X2	H
920 508	40/ 32	30	30	80
920 516	50/ 40	30	30	80
920 525	63/ 40	30	30	80
920 526	63/ 50	30	30	80
920 530	75/ 40	30	30	80
920 531	75/ 50	30	30	80
920 533	75/ 63	30	30	80
920 535	90/ 40	30	30	80
920 536	90/ 50	30	30	80
920 538	90/ 63	30	30	80
920 539	90/ 75	30	30	80
920 542	110/ 40	30	30	80
920 543	110/ 50	30	30	80
920 545	110/ 63	30	30	80
920 546	110/ 75	30	30	80
920 547	110/ 90	30	30	80
920 550	125/ 50	30	30	80
920 552	125/ 63	30	30	80
920 553	125/ 75	30	30	80
920 554	125/ 90	30	30	80
920 555	125/110	30	30	80
920 558	160/110	32	29	100
920 560	160/125	32	32	100
920 562	200/160	100	100	250
920 564	250/200	120	120	270
920 566	315/250	130	130	325

### Concentric reducer

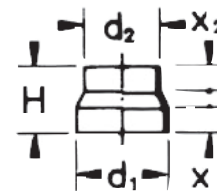

## Product list

Art.nr	d1/d2	X1	X2	H
920 608	40/ 32	25,5	25,5	65
920 616	50/ 40	35	37	80
920 625	63/ 40	35	37	80
920 626	63/ 50	35	37	80
920 630	75/ 40	33	30	80
920 631	75/ 50	35	37	80
920 633	75/ 63	35	37	80
920 635	90/ 40	30	34	80
920 636	90/ 50	31	34	80
920 638	90/ 63	31	38	80
920 639	90/ 75	31	43	80
920 642	110/ 40	31	34	80
920 643	110/ 50	31	34	80
920 645	110/ 63	35	37	80
920 646	110/ 75	31	36	80
920 647	110/ 90	35	37	80
920 653	125/ 75	35	30	80
920 654	125/ 90	35	32	80
920 655	125/110	36	36	80
920 671	160/110	35	37	80
920 672	160/125	35	37	80

Eccentric reducer

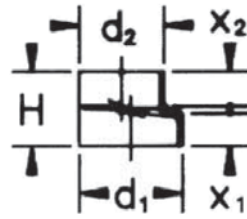

920 675	200/110	110	60	325
920 676	200/125	110	70	310
920 678	200/160	110	90	270
920 690	250/200	130	110	325
920 698	315/250	150	130	395

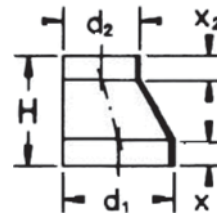

Art.nr.	d1	$\alpha$	X1	r
921 542	110	15°	45	80

Elbow 15°

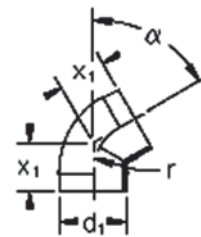

Art.nr.	d1	X1
921 500	40	35
921 508	50	40
921 516	63	45
921 544	110	55
921 554	125	60
921 562	160	80
920 920 (segment welded)	200	115

Elbow 30°

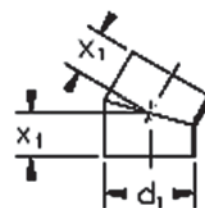



## Product List

Art.nr.	d1	X1
921 232	32	25
921 234	40	40
921 254	50	45
921 274	63	50
921 284	75	50
921 294	90	55
921 304	110	60
921 314	125	65
921 334	160	100
921 354 (short radius)	200	160
921 374 (segment welded)	250	165
921 394 (segment welded)	315	230

Elbow 45°

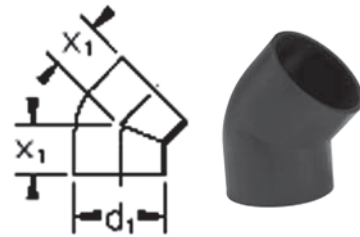

Art.nr.	d1	X1
921 502	40	45
921 510	50	55
921 546	110	80
921 566	160	120

Elbow 60°



Art.nr.	d1	X1
921 238	40	60
921 258	50	70
921 519 (long radius)	63	80
921 528	75	75
921 298	90	80
921 548	110	95
921 558	125	125
921 568	160	180

Elbow 88 1/2°

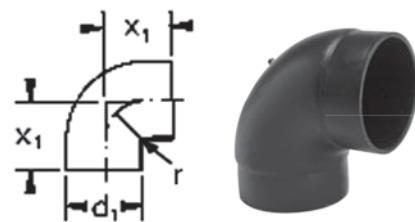

Art.nr.	d1	X1
921 013	160	140
921 015	200	250
921 017	250	335
921 019	315	370

Elbow 90°  
segment welded

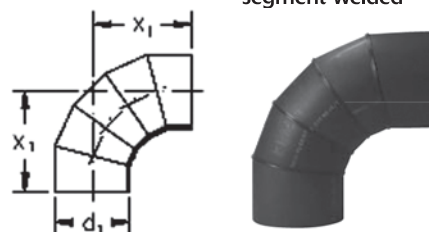

Art.nr.	d1	X1	X2	r
921 002	32	100	30	30
921 003	40	150	30	30
921 005	50	180	40	40
921 007	63	210	50	50
921 008	75	210	70	70
921 009	90	240	90	90
921 010	110	270	103	100
921 011	125	200	110	110

Elbow 90°  
extended

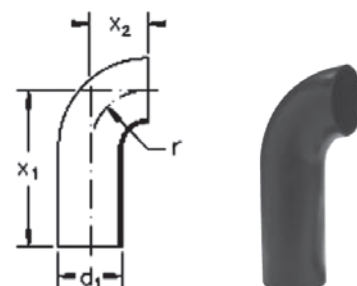

## Product list

Reduced elbow 90°

Art.nr.	d1/d2	X1-X2	r
921 716	50/40	50	50
921 726	63/50	50	50

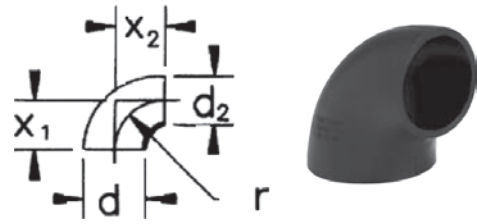

Art.nr	d1	X1	X2
921 843	40	35	70
921 845	50	49	100
921 846	63	63	128
921 847	75	75	148
921 849	90	90	176
921 850	110	103	198

U-bend 180°

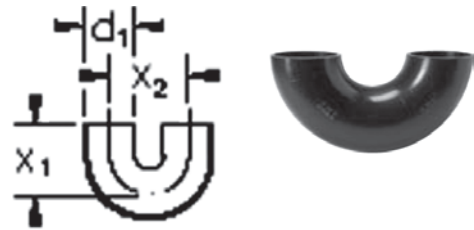

Art.nr.	d1/d2	X1	X2	X3	H
922 280	110	170	140	100	270

Airy branch 88 1/2°

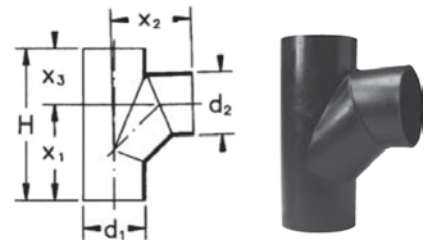

Art.nr.	d1/d2	X1	X2-X3	H
922 336	90/ 50	80	160	240
922 342	110/ 40	80	180	260
922 343	110/ 50	80	180	260
922 348	110/110	80	180	260
922 350	125/110	100	200	300

Double branch 45°

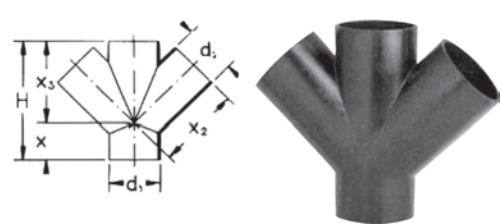

Art.nr.	d1/d2	X1	X2
922 816	50/ 40	55	110
922 818	50/ 50	45	95
922 826	63/ 50	70	130
922 828	63/ 63	45	95
922 836	110/ 90	35	140
922 848	110/110	90	120

Y-branch 30°

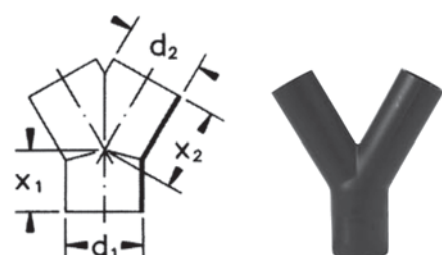

## Product List

Art.nr	d1/d2	X1	X2-X3	H
922 005	32/ 32	35	70	105
922 008	40/ 32	45	90	135
922 009	40/ 40	45	90	135
922 016	50/ 40	55	110	165
922 018	50/ 50	55	110	165
922 025	63/ 40	65	130	195
922 026	63/ 50	65	130	195
922 028	63/ 63	65	130	195
922 030	75/ 40	70	140	210
922 031	75/ 50	70	140	210
922 033	75/ 63	70	140	210
922 034	75/ 75	70	140	210
922 035	90/ 40	80	160	240
922 036	90/ 50	80	160	240
922 038	90/ 63	80	160	240
922 039	90/ 75	80	160	240
922 040	90/ 90	80	160	240
922 042	110/ 40	90	180	270
922 043	110/ 50	90	180	270
922 045	110/ 63	90	180	270
922 046	110/ 75	90	180	270
922 047	110/ 90	90	180	270
922 048	110/110	90	180	270
922 050	125/ 50	100	200	300
922 052	125/ 63	100	200	300
922 053	125/ 75	100	200	300
922 054	125/ 90	100	200	300
922 055	125/110	100	200	300
922 056	125/125	100	200	300
922 071	160/110	125	250	375
922 072	160/125	125	250	375
922 074	160/160	125	250	375
922 075	200/110	180	360	540
922 076	200/125	180	360	540
922 078	200/160	180	360	540
922 079	200/200	180	360	540
922 086	250/110	220	440	660
922 087	250/125	220	440	660
922 089	250/160	220	440	660
922 090	250/200	220	440	660
922 092	250/250	220	440	660
922 093	315/110	280	560	840
922 094	315/125	280	560	840
922 095	315/160	280	560	840
922 096	315/200	280	560	840
922 098	315/250	280	560	840
922 099	315/315	280	560	840

Branch 45°

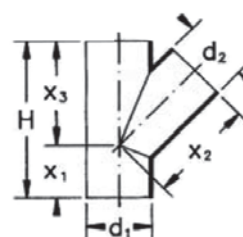

Art.nr.	d1/d2	X1	X2-X3	H
922 205	32/ 32	50	50	100
922 208	40/ 32	75	55	130
922 209	40/ 40	75	55	130
922 216	50/ 40	90	60	150
922 218	50/ 50	90	60	150
922 225	63/ 40	105	70	175
922 226	63/ 50	105	70	175
922 228	63/ 63	105	70	175
922 230	75/ 40	105	70	175
922 231	75/ 50	105	70	175
922 233	75/ 63	105	70	175
922 234	75/ 75	105	70	175
922 235	90/ 40	120	80	200
922 236	90/ 50	120	80	200
922 238	90/ 63	120	80	200
922 239	90/ 75	120	80	200
922 240	90/ 90	120	80	200
922 242	110/ 40	135	90	225
922 243	110/ 50	135	90	225
922 245	110/ 63	135	90	225
922 246	110/ 75	135	90	225
922 247	110/ 90	135	90	225
922 248	110/110	135	90	225
922 252	125/ 63	150	100	250
922 253	125/ 75	150	100	250
922 254	125/ 90	150	100	250
922 255	125/110	150	100	250
922 256	125/125	150	100	250
922 271	160/110	210	140	350
922 272	160/125	210	140	350
922 274	160/160	210	140	350
922 275	200/110	180	180	360
922 276	200/125	180	180	360
922 278	200/160	180	180	360
922 279	200/200	180	180	360
922 286	250/110	220	220	440
922 287	250/125	220	220	440
922 289	250/160	220	220	440
922 290	250/200	220	220	440
922 292	250/250	220	220	440
922 293	315/110	280	280	560
922 294	315/125	280	280	560
922 295	315/160	280	280	560
922 296	315/200	280	280	560
922 298	315/250	280	280	560
922 299	315/315	280	280	560

Branch 88

1/2°

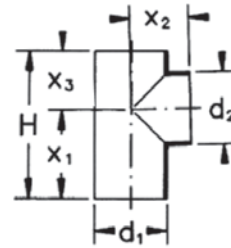

Spherical branches,  
2 stubs

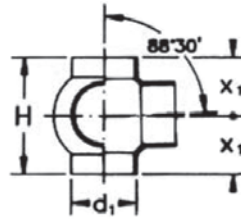

Type A - 180°

Art.nr.	d1/d2-d3	X1	X2-X3	H
922 443	110/ 50	100	120	200
922 445	110/ 63	100	120	200
922 446	110/ 75	100	120	200
922 447	110/ 90	100	120	200
922 448	110/110	100	120	200
922 450	125/ 50	100	125	200
922 453	125/ 75	100	125	200
922 455	125/110	100	125	200

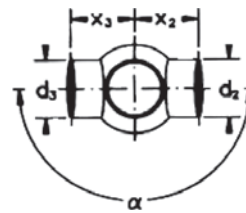

Type B - 90°

Art.nr.	d1/d2-d3	X1	X2-X3	H
922 517	110/ 50	100	120	200
922 519	110/ 63	100	120	200
922 520	110/ 75	100	120	200
922 521	110/ 90	100	120	200
922 522	110/110	100	120	200
922 523	125/ 50	100	125	200
922 526	125/ 75	100	125	200
922 528	125/110	100	125	200

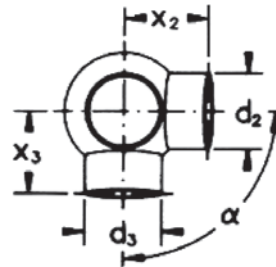

Type C - 135°

Art.nr.	d1/d2-d3	X1	X2-X3	H
922 567	110/ 50	100	120	200
922 569	110/ 63	100	120	200
922 570	110/ 75	100	120	200
922 571	110/ 90	100	120	200
922 572	110/110	100	120	200
922 573	125/ 50	100	125	200
922 576	125/ 75	100	125	200
922 578	125/110	100	125	200

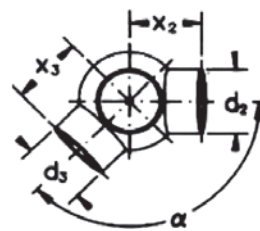

Spherical branches,  
3 stubs

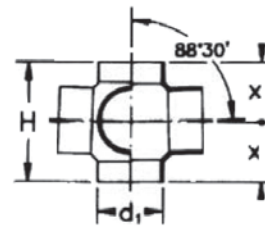

Type D - 135°

Art.nr.	d1/d2-d3-d4	X1	X2-X3-X4	H
922 667	110/ 50	100	120	200
922 670	110/ 75	100	120	200
922 671	110/ 90	100	120	200
922 672	110/110	100	120	200
922 673	125/ 50	100	125	200
922 676	125/ 75	100	125	200
922 678	125/110	100	125	200

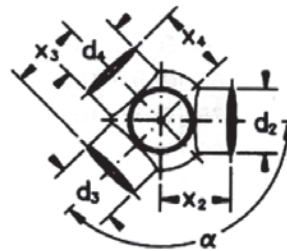

Type E - 90°

Art.nr.	d1/d2-d3-d4	X1	X2-X3-X4	H
922 617	110/ 50	100	120	200
922 620	110/ 75	100	120	200
922 621	110/ 90	100	120	200
922 622	110/110	100	120	200
922 623	125/ 50	100	125	200
922 626	125/ 75	100	125	200
922 628	125/110	100	125	200

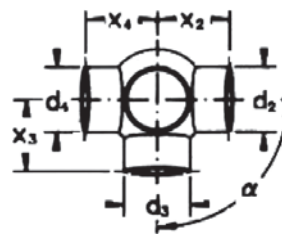

Type F - 90°

Art.nr.	d1/d2-d3-d4-d5	X1	X2-X3-X4-X5	H
922 717	110/ 50	100	120	200
922 720	110/ 75	100	120	200
922 721	110/ 90	100	120	200
922 722	110/110	100	120	200
922 723	125/ 50	100	125	200
922 726	125/ 75	100	125	200
922 728	125/110	100	125	200

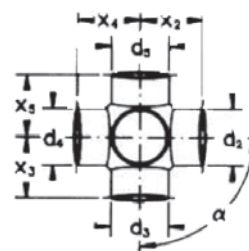

Spherical branches,  
4 stubs



## Product List

Art.nr.	d1/d2	X1	X2	X3	H
920 709	90/ 90	80	200	160	240
920 711	110/110	90	230	180	270
920 712	125/110	100	250	200	300
920 716	160/110	125	300	250	375

Access fitting 45°

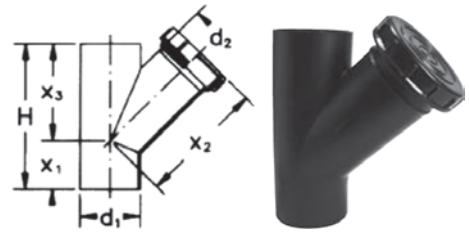

Art.nr.	d1/d2	X1	X2	X3	H
920 863	40/ 40	75	70	50	125
920 865	50/ 50	90	85	60	150
920 867	63/ 63	105	80	70	175
920 868	75/ 75	105	90	70	175
920 869	90/ 90	120	100	80	200
920 870	110/110	135	125	90	225
920 871	125/110	150	130	100	250
920 873	160/110	210	150	140	350
920 875	200/110	180	170	180	360
920 877	250/110	220	190	220	440
920 879	315/110	280	210	280	560

Access fitting 88 1/2°

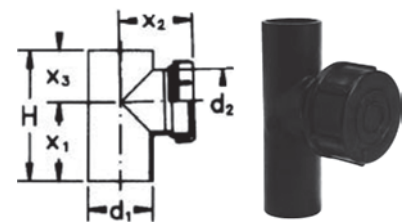

Art.nr.	d1/de	t	H
923 021	90/132	60	90
923 031	110/132	60	90

Floor mounted toilet connector

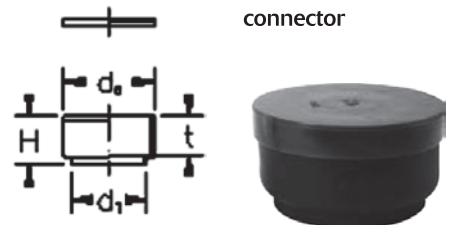

Art.nr.	d1/de	t	H
923 006	90/120	95	125
923 016	110/120	95	125

Floor mounted toilet connector, long

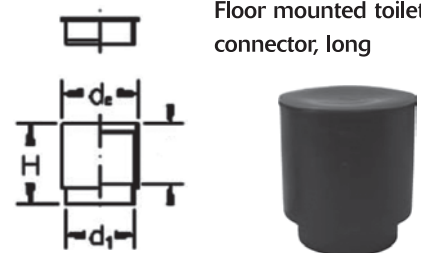

Art.nr.	d1	X1	X2
923 097	110	300	180

Constant diameter toilet elbow 90°

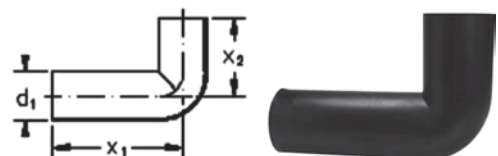

## Product list

Art.nr.	d1	X1	X2
921 139	90	270	50
921 140	110	300	60

Connecting  
elbow 90° - smooth

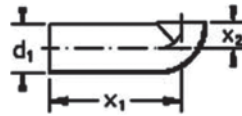

Art.nr.	d1/de	X1	t	H
923 072	90/132	270	60	120
923 082	110/132	300	55	120

Toilet elbow 88 1/2°  
Type A

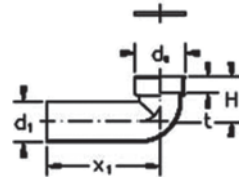

Art.nr.	d1/de	X1	t	H
923 057*	90/120	270	120	160
923 067	110/120	300	120	185

\*with notch

Toilet elbow 88 1/2°  
extended - Type B

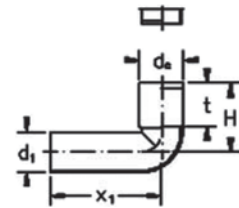

Art.nr.	d1/de	X1	t	H
923 087	110/132	300	120	185

Universal toilet  
elbow Type C

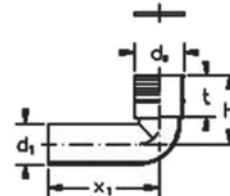

Art.nr.	d1/d2	de	X1	X2	t	H
926 002	90/40	120	270	180	120	160
926 004	90/50	120	270	180	120	160
926 006	110/40	120	300	150	140	185
926 008	110/50	120	300	150	140	185

Ø 190 with notch

Ø 110 with asymmetrical junction

Long-spigot toilet  
elbow with right stub

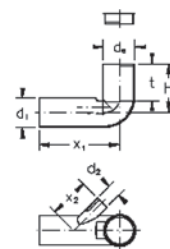

Art.nr.	d1/d2	de	X1	X2	t	H
926 001	90/40	120	270	180	120	160
926 003	90/50	120	270	180	120	160
926 005	110/40	120	300	150	140	185
926 007	110/50	120	300	150	140	185

Ø 190 with notch

Ø 110 with asymmetrical junction

Long-spigot toilet  
elbow with left stub

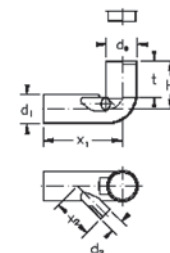



## Product List

Art.nr.	d1/d2	de	X1	X2	t	H
926 010	90/40	120	270	180	120	160
926 011	90/50	120	270	180	120	160
926 012	110/40	120	300	150	140	185
926 013	110/50	120	300	150	140	185

Ø 90 with notch  
Ø 110 with asymmetrical junction

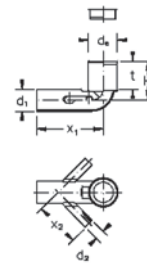

Long-spigot toilet elbow with double stub



Art.nr.	d1/d2	de	X1	X2	t	H
923 107	110/40	120	300	150	140	185
923 108	110/50	120	300	150	140	185

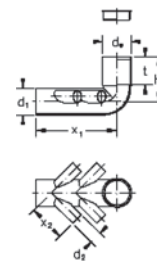

Long-spigot toilet elbow with 4 stubs



Art.nr.	d	Type of connection
308 020	120	Toilet elbow - Type B
308 010	135	C elbow - Type A - C
308 107*	107	Floor mounted elbow

\* Allows the connection between the toilet discharge fitting and the long toilet elbow.



Floor mounted toilet connection gasket



Art.nr.	d1/di	de	t	H
924 227	90/ 90	110	28	38
923 204	110/ 90	110	25	30
924 228	110/110	131	28	38



Wall mounted toilet connector

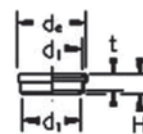

Art.nr.	d1/di	de	X1	t	H
923 281	90/ 90	110	225	34	75
923 280	110/ 90	110	225	34	75
923 285	110/110	131	300	33	75

Wall mounted toilet connector elbow 90° for hanging toilets

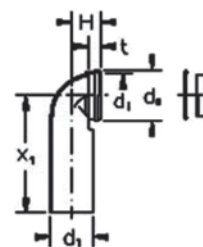

## Product list

Art.nr.	d1/di	de	X1	t	H
923 358	110/110	131	195	28	270

Wall mounted double toilet connector elbow 90°

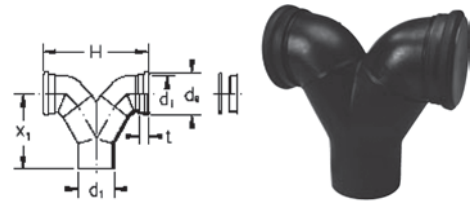

Art.nr.	d1/di	de	X1	X2	t	H
923 327	110/110	131	310	100	28	95

Wall mounted toilet offset connector elbow 90° for horizontal assembly, right-handed

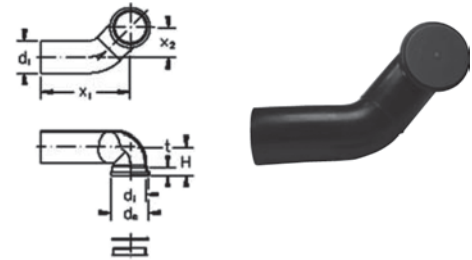

Art.nr.	d1/di	de	X1	X2	t	H
923 317	110/110	131	310	100	28	95

Wall mounted toilet offset connector elbow 90° for horizontal assembly, left-handed

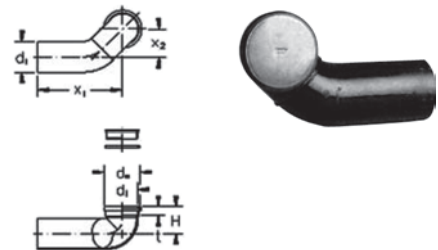

Art.nr.	d1/di	de	X1	X2	t	H
923 337	110/110	131	340	100	28	270

Wall mounted double connector elbow 90° for horizontal assembly

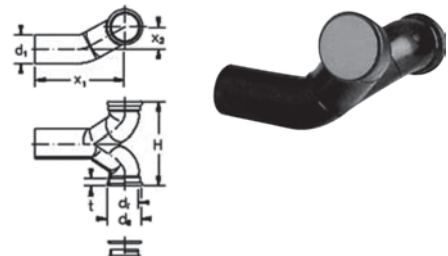

All fittings are supplied with gasket and protection cap.

Art.nr.	d1	de	$\alpha$	X1	t	H
923 558	90	132	45°	330	60	145
923 559	90	132	90°	285	60	145
923 551	110	132	0°	290	60	165
923 552	110	132	45°	380	60	165
923 555	110	132	90°	330	60	165

Lavatory pan trap (toilet) 0° - 45° - 90°

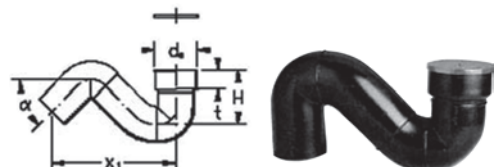

## Product List

Art.nr.	d1	X1	H
929 992	110	580	200
929 993	125	720	250

Trap "Firenze"

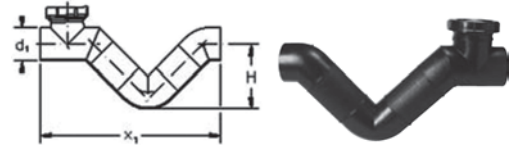

Art.nr.	d1/di	t	H
923 603	32/46	25	35
923 606	40/46	25	35
923 612	50/46	25	35

Outlet connectors

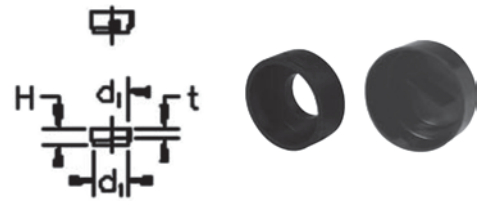

Art.nr.	d1/di	X1	t	H
923 623	32/46	60	20	50
923 626	40/46	60	20	50
923 632	50/46	60	20	50

Outlet connector elbow

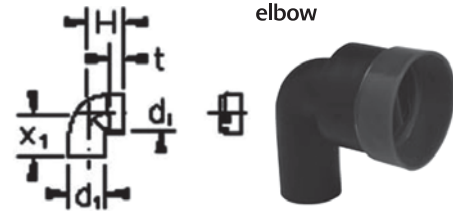

### Universal type

Art.nr.	d	d1
308 042	46	1" - 1 1/4"
308 044	46	1 1/2"

Rubber gasket



Art.nr.	d1/di	t	H
923 565	40/46	21	77

High rinse box drainage

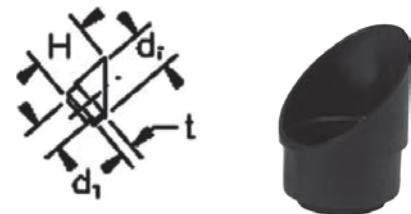

**Universal type (WAVIDUO)**

Art.nr.	d1	de	H
910 104	40	54	52
910 105	50	64	52
910 106	63	77	52
910 107	75	90	52
910 109	90	104	54
910 111	110	124	64
910 112	125	143	64
910 116	160	180	63

Electro-fusion coupler

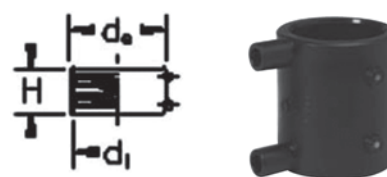

To be welded with:

Electro-fusion welding box Code 700020, or other universal welding machine for electro-fusion couplers Ø 40 to Ø 160.

**Wavin type (WAVISOLO)**

Art.nr.	d1	de	H
910 004	40	54	54
910 005	50	64	54
910 006	63	77	54
910 007	75	90	54
910 009	90	103	56
910 011	110	122	58
910 012	125	137	67
910 016	160	181	95
910 020	200	231	150
910 025	250	286	150
910 031	315	352	150

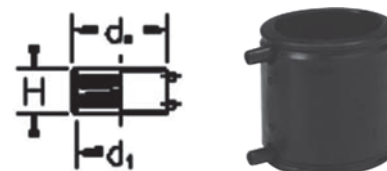

Only to be welded with:

Electro-fusion welding box Type Wavin Code 701315 for electro-fusion couplers Ø 40 to Ø 315.

Art.nr.	d1/di	de	t	H
924 202	32/ 32	47	35	50
924 203	40/ 40	57	50	85
924 205	50/ 50	67	50	85
924 207	63/ 63	79	52	85
924 208	75/ 75	92	65	100
924 209	90/ 90	110	70	105
924 210	110/110	131	70	105
924 211	125/125	150	75	115
924 213	160/160	190	93	140

Push-fit socket with gasket and cap



## Product List

Art.nr.	d1/di	de	t	H
924 103	40/ 40	57	170	235
924 105	50/ 50	67	170	235
924 107	63/ 63	80	175	235
924 108	75/ 75	92	179	240
924 109	90/ 90	110	175	240
924 110	110/110	130	178	255
924 111	125/125	148	180	255
924 113	160/160	188	190	285
924 115	200/200	225	200	345
924 117	250/250	280	250	405
924 119	315/315	350	250	405

Expansion socket with gasket and cap

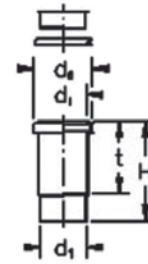

The expansion sockets with  $\varnothing$  from 40 to 315 mm absorb the expansion and the contraction of a 5000 mm long pipe. 10°C temperature difference = 2 mm expansion or contraction per meter.

On the expansion socket the push-in depth of the pipe at a room temperature of 0°C and + 20°C is mentioned.

Push-fit depth in mm

$\varnothing$	-10°	0°	+10°	+20°
40 - 160	70	80	90	105
200 - 315	170	180	190	205

Expansion socket  $\varnothing$  110 mm

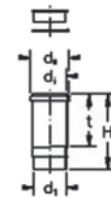

The expansion socket with  $\varnothing$  110 has an external ring for fixed-point bracket.

Art.nr.	d1	de	h	H
924 303	40	64	30	50
924 306	50	74	34	58
924 310	63	87	36	63
924 311	75	103	42	65
924 312	90	125	46	82
924 313	110	145	57	90

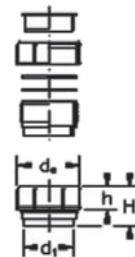

Complete screw connection



Art.nr.	d1	X1	H
924 363	40	29	62
924 366	50	33	70
924 370	63	37	79
924 371	75	38	81
924 372	90	48	101
924 373	110	52	110

Bushes

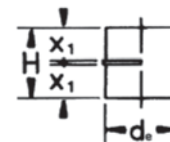

Art.nr.	d1	de	H
924 443	40	64	45
924 446	50	74	55
924 450	63	87	40
924 451	75	103	45
924 452	90	123	45
924 453	110	145	50

Complete closing cap

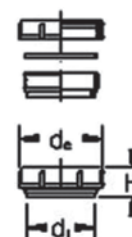

## Product list

Art.nr.	d1	H
924 622 (short version)	32	5
924 623	40	38
924 625	50	38
924 627	63	38
924 628	75	38
924 629	90	40
924 630	110	45
924 631	125	46
924 633	160	48

Weld cap

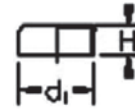

Art.nr.	d1	H
929 004	40	30
929 005	50	30
929 006	63	30
929 007	75	30
929 009	90	31
929 011	110	33
929 012	125	36
929 016	160	36

Protection cap for pipes and fittings

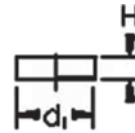

Flange connections

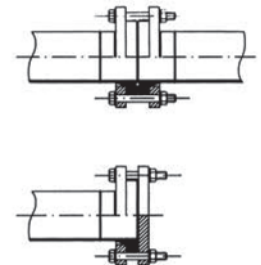
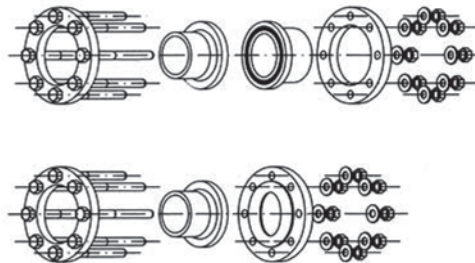

Art.nr.	d1	di	de	K	S	bolts no.	thread
309 121	50	62	150	110	16	4	M16
309 122	56-63	78	165	125	16	4	M16
309 123	75	92	185	145	16	4	M16
309 124	90	108	200	160	18	8	M16
309 125	110	128	220	180	22	8	M16
309 127	125	135	220	180	22	8	M16
309 126	125	158	250	210	22	8	M16
309 128	160	178	285	240	24	8	M20
309 129	200	235	340	295	26	8	M20
309 119	250	288	395	350	28	12	M20
309 120	315	338	445	400	28	12	M20

Flanges

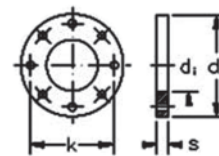

## Product list

Art.nr.	d1	de	h	H
926 521	50	88	17	60
926 522	63	102	19	65
926 523	75	122	21	70
926 524	90	138	22	70
926 525	110	158	24	80
926 527	125	158	24	80
926 526	125	188	24	80
926 528	160	212	24	85
926 529	200	268	24	140
926 519	250	320	27	145
926 520	315	370	27	145



Bushes to be welded



Art.nr.	d1	di	de	S
309 250	250	252	328	4
309 251	315	302	378	4

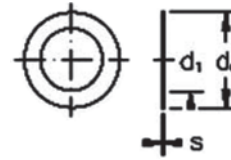

Flat gaskets for blind flanges



N.B. for diameter 50-200 mm, use the gasket EPDM out of the Wavin HDPE80-HDPE100 product range. Please see below.

### EPDM

Art.nr.	d1	de	S
904 402	132	170	3
904 403	140	182	3
904 404	150	192	3
904 405	163	107	3
904 406	175	127	3
904 407	190	142	3
904 408	110	162	3
904 461	140		
904 462	160	218	3
904 463	200/225	273	4
904 467	280		

Art.nr.	d1	G	H
924 734	40	3/4"	60
924 735	40	1"	60
924 736	40	1-1/4"	60
924 737	40	1-1/2"	60
924 739	40	2"	67
924 743	50	3/4"	75
924 755	50	1"	60
924 756	50	1-1/4"	60
924 757	50	1-1/2"	60
924 758	50	2"	60
924 760	63	2"	82



Brass nut connections



## Product list

Art.nr.	d1	G	t	H
307 031	40	1/2"	20	55
307 033	40	3/4"	20	55
307 035	40	1"	20	55
307 039	50	1/2"	20	55
307 041	50	3/4"	22	55
307 043	50	1"	24	55
307 045	50	1-1/4"	20	55
307 047	50	1-1/2"	22	55
307 049	50	2"	24	87
307 051	63	2"	24	94

Internal thread joints

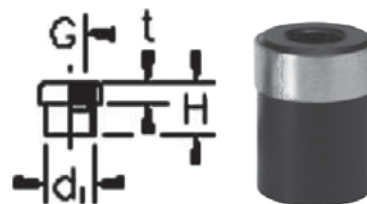

Art.nr.	d1	G	t	H
307 060	50	1-1/4"	25	60
307 062	50	1-1/2"	26	60
307 064	63	2"	25	60

External thread joints

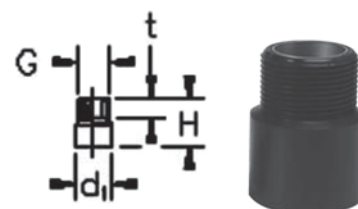

Art.nr.	d1	di	t	H	Ø connection
925 915	50	68	80	250	45 ÷ 60
925 917	63	91	85	250	60 ÷ 82
925 918	75	100	90	250	70 ÷ 92
925 919	90	111	100	250	85 ÷ 102
925 920	110	132	90	250	105 ÷ 124
925 921	125	156	100	250	120 ÷ 148
925 922	160	180	100	250	155 ÷ 172
925 916	200	220	100	250	195 ÷ 212

Shrink-on sockets with seal



Other Ø on request.

Art.nr.	d1/d2	t	H
925 925	110/100	75	105

Adaptors to PVC

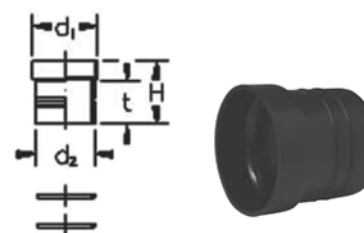

Art.nr.	d1/d2	X1	X2	H
929 997	110/40	100	105	500
929 998	110/50	100	105	500

Connection with 4 stubs

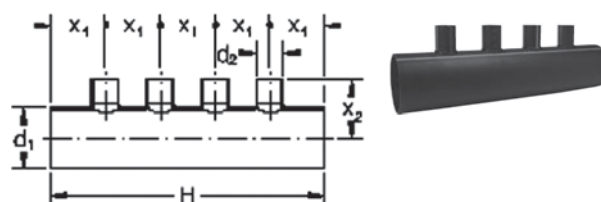



## Product List

### Roof gullies

Art.nr.	di	de	Flow capacity
982 502	53	FM 2"	12 l/s
982 632	69	FM 2" 1/2	24 l/s

Gullies without counterflange



Art.nr.	di	de	Flow capacity
982 501	53	FM 2"	12 l/s

Gullies with counterflange

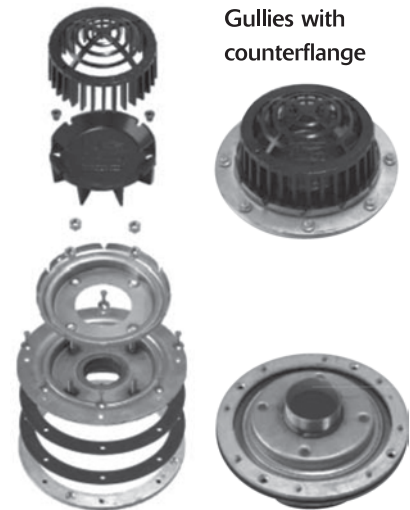

Art.nr.	di	de	Flow capacity
982 531	53	FM 2"	12 l/s
982 532	69	FM 2" 1/2	24 l/s

Gullies for bitumen rooftop



**Bracketing system**

Art.nr.	Description
982 610	Guiding rail 6 mt
982 611	Fixing system 6 mt, $\varnothing$ 40
982 612	Fixing system 6 mt, $\varnothing$ 50
982 613	Fixing system 6 mt, $\varnothing$ 63
982 614	Fixing system 6 mt, $\varnothing$ 75
982 615	Fixing system 6 mt, $\varnothing$ 90
982 616	Fixing system 6 mt, $\varnothing$ 110
982 617	Fixing system 6 mt, $\varnothing$ 125
982 618	Fixing system 6 mt, $\varnothing$ 160

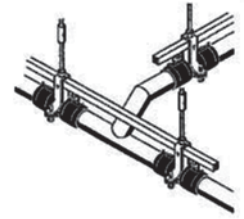

The fixing system includes the guiding rails and fixing brackets.

**Accessories**

Art.nr.  
982 516

Insulation for gully  
53/69

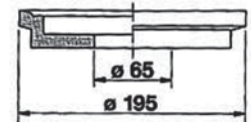

Art.nr.  
982 519

Heating plate + 1 meter  
cable

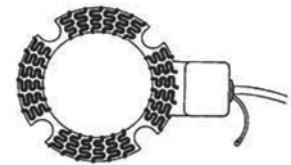

Art.nr.	Di
982 538	12
982 540	15
982 539	18
982 541	20
982 542	25
982 543	30
982 544	35
982 545	40

Reducing plate

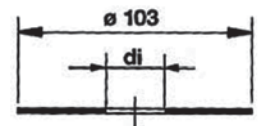

Art.nr.	D
982 518	50x2"
982 526	63x2" 1/2

Transition coupler HDPE

## Product List

**Art.nr.**  
982 517

**D**  
50x2"

Transition elbow 90°  
HDPE + nut

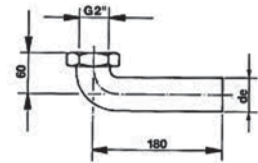

**Art.nr.**  
982 514

Sheet in TG 66

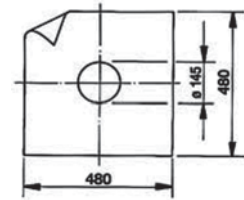

**Art.nr.**  
982 515

Sheet in PVC

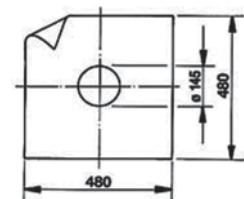

**Art.nr.**  
982 522

**D**  
200

Ring for gravel roof,  
high

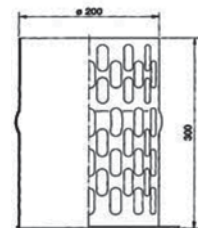

**Art.nr.**  
982 523

**D**  
200

Ring for gravel roof,  
low

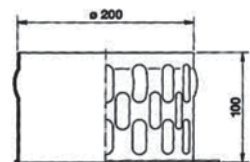

**Art.nr.**  
982 600  
982 601

**D**  
50  
63

Seal set for fixing  
(roof)

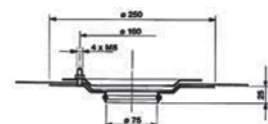

## Product list

Art.nr.	D
982 621	50
982 622	63

O-ring

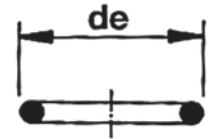

Art.nr.
982 513

Sheet

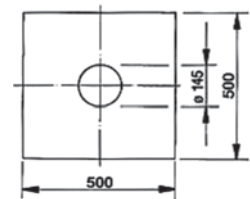

Art.nr.	D
982 521	180

Ring for asphalt roof



Art.nr.
982 508

Counterflange, 8 holes

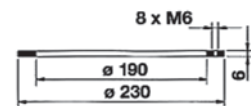

Spare parts

Art.nr.
982 507

Inlet base, 8 holes

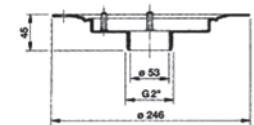

Art.nr.
982 505

Fixing ring

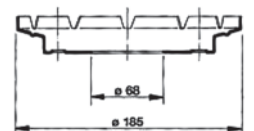

Art.nr.
982 503

Protection cap, aluminium

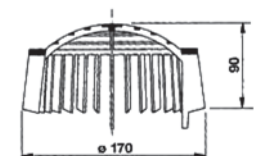

Art.nr:  
982 504

Flow stabiliser T5 in  
aluminium

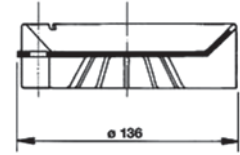

Art.nr:  
982 512

Dimensions  
2x145x185

Flat seal for inlet base

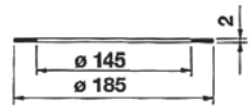

Art.nr:  
982 510

Flat seal for counterf-  
lange in EPDM

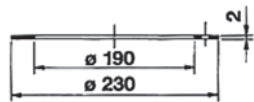

Art.nr:  
982 528

Hexacon  
screws/bolts,  
M6 x 20 mm

Art.nr:  
982 527

Nut M8 x 100 mm

## Product list

### Welding equipment

Art.nr.	Ø	Description
700 020	40 - 160	Electrofusion machine
700 100	40 - 160	Spare cable

Electro welding machine - Universal Type (WAVIDUO)



Supply voltage 220 V~ 50 Hz

Art.nr.	Ø	Description
701 315	40 - 315	Electrofusion machine
700 107	40 - 315	Spare cable

Electro welding machine - Wavin T



Art.nr.	Ø Welding
700 016	200
700 017	300

Welding mirror complete with metal case

- with thermostat
- teflon-coated
- complete with supports
- metal carrying case
- 800 W
- supply voltage 220 V ~ 50 Hz



Art.nr.	Ø	Description
700 015	40 ÷ 160	Welding machine
701 022	40 ÷ 160	Spare blade

Mini supra

Welding machine provided with:

- teflon-coated thermoplate
- electric rotary planer
- set of jaws Ø 160 and reducers to be used for welding diameters 40/50/63/75/90/110/125/160 mm



Art.nr.	Ø	Description
700 014	40 ÷ 160	Welding machine
701 022	40 ÷ 160	Spare blade

Universal 160

Welding machine provided with:

- teflon-coated thermoplate 220 V, 800 W, self-centering
- motorized facing miller supplied with right/left lock
- carriage with rack and check of the constant pressure
- jaws which can weld (by universal welding) branches 45°, 60°, 88 1/2°, fittings, elbows and pipes from Ø 40 - 160 mm



## Product list

Art.nr.	Ø	Description
700 002	75 ÷ 250	Welding machine
701 024	75 ÷ 250	Spare blade

Welding machine provided with:

- electric rotary planer with microswitch incorporated in the handle
- teflon-coated thermoplate Ø 300 - 200 V, 1300 W
- set of jaws Ø 250 and reducers to be used for welding diameters 75/90/110/125/160/200

Media 250



---

Art.nr.	Ø	Description
700 003	125 ÷ 315	Welding machine
701 026	125 ÷ 315	Spare blade

Welding machine provided with:

- electric rotary planer with microswitch incorporated in the handle
- teflon-coated thermoplate Ø 340 - 220 V, 1800 W
- set of jaws and reducers to be used for welding diameters 315/250/200/160/125
- assembled on trolley

Maxi 315





**NOTES**

A series of horizontal dashed lines for writing notes.





**NOTES**

A series of horizontal dashed lines for writing notes.



**NOTES**

A series of horizontal dashed lines for writing notes.





## HEAD OFFICE

### HEPWORTH PME LLC DUBAI

P.O.Box 2345, Dubai, UAE  
Tel: +971 4 2894670  
Fax: +971 4 2894620 /1  
Email: info@corys.ae

### SALES/CUSTOMER SERVICE

customer.service@corys.ae

## U.A.E. OFFICES

### ABU DHABI

P.O. Box: 4894, Abu Dhabi, UAE  
Tel: +971 2 6727585  
Fax: +971 2 6783578  
Email: hpmeauh@corys.ae

### AL AIN

P.O. Box: 80862, Al Ain, UAE  
Tel: +971 3 7210727  
Fax: +971 3 7211292  
Email: hpmealn@corys.ae

---

## QATAR OFFICE

### DOHA

HEPWORTH PME (QATAR) W.L.L.  
P.O. Box 50207, Doha, Qatar  
Tel: +974 44506810  
Fax: +974 44506811  
Email: info@hepworthpme.com.qa

### MESAIEED

HEPWORTH PME (QATAR) W.L.L.  
P.O. Box 50207, Mesaieed, Qatar  
Tel: +974 44760588  
Fax: +974 44760525

---

## OMAN

CORYS PIPE INDUSTRY LLC  
P.O Box: 117, PC 130,  
Muscat, Sultanate of Oman  
Tel: +96824217626/20  
Fax: +968 24210032  
Email: info.oman@corys.ae

---

## BAHRAIN

HEPWORTH W.L.L.  
Building 1, Avenue 0010  
P.O. Box 143, Manama, Bahrain  
Tel: +973 17672050  
Fax: +973 17672583  
Email: info.bahrain@corys.ae

---

## SAUDI ARABIA

ABDUL GHAFFAR INDUSTRIES LLC  
Al Nuwar Bint Malik Street,  
Building 18 - Al Rawdah District  
Tel: +966 547900444  
Email: info.ksa@corys.ae

[www.hepworth.ae](http://www.hepworth.ae)